

Dimensional Document

Viega PureFlow® Crimp Eco Brass® Fittings



This document is subject to updates. For the most current Viega technical literature, please visit www.viega.us.



Viega products are designed to be installed by licensed and trained plumbing and mechanical professionals who are familiar with Viega products and their installation. **Installation by non-professionals may void Viega LLC's warranty.**



Zero Lead identifies Viega products meeting the lead free requirements of NSF/ANSI/CAN 61 through testing under NSF/ANSI/CAN 372 (0.25% or less maximum weighted average lead content).



Eco Brass is a high grade, zero-lead alloy with high strength and corrosion resistance.

Viega PureFlow Crimp 90° Elbow Zero Lead Brass Crimp x MPT - Model V5014ZL

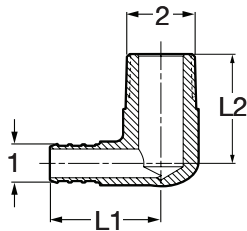

Part No.	Size (in)		L1 (in)		L2 (in)	
	1	2	Dec	Frac	Dec	Frac
46822	3/8	3/8 MPT	1.03	1/16	0.96	15/16
46232	1/2	3/8 MPT	1.29	15/16	0.96	15/16
46821	1/2	1/2 MPT	1.11	1/8	1.19	13/16
46245	3/4	3/4 MPT	1.50	1/2	1.26	11/4

Viega PureFlow Crimp 90° Elbow Drop Ear Zero Lead Brass Crimp x FPT - Model V5027ZL

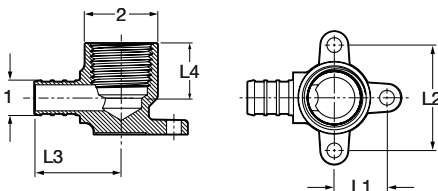

Part No.	Size (in)		L1 (in)		L2 (in)		L3 (in)		L4 (in)	
	1	2	Dec	Frac	Dec	Frac	Dec	Frac	Dec	Frac
46233	1/2	1/2 FPT	0.79	13/16	1.58	1/16	1.39	1/8	0.72	3/4
46244	3/4	3/4 FPT	0.99	1	1.98	2	1.46	1/16	1.05	1/16

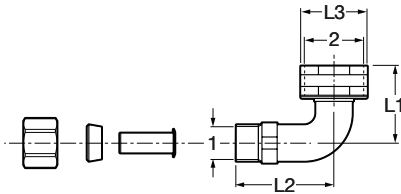
Viega PureFlow Compression 90° Elbow For Dishwasher Zero Lead Copper CTS x Hose - Model V5053

Part No.	Size (in)	L1 (in)		L2 (in)		L3 (in)	
		1	2	Dec	Frac	Dec	Frac
46743	3/8 CTS (1/2 O.D.) Comp x 3/4 Hose	1.32	1 5/16	1.67	1 11/16	1.14	1 1/8

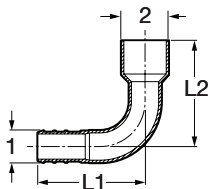
Viega PureFlow Crimp 90° Elbow Zero Lead Copper Crimp x C - Model V5021

Part No.	Size (in)	L1 (in)		L2 (in)	
		1	2	Dec	Frac
44305	3/8 x 1/2 C	1.68	1 11/16	1.46	1 7/16
44325	1/2 x 1/2 C	1.43	1 7/16	1.58	1 9/16
44345	3/4 x 3/4 C	2.05	2 1/16	2.01	2

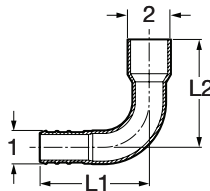
Viega PureFlow Crimp 90° Elbow Zero Lead Copper Crimp x FTG - Model V5020

Part No.	Size (in)	L1 (in)		L2 (in)	
		1	2	Dec	Frac
44302	3/8 x 1/2 FTG	1.65	1 5/8	1.56	1 9/16
44320	1/2 x 1/2 FTG	1.44	1 7/16	1.49	1 1/2
44340	3/4 x 3/4 FTG	1.94	1 15/16	1.87	1 7/8

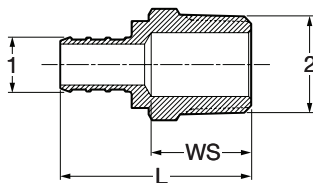
Viega PureFlow Crimp Adapter Zero Lead Brass Crimp x MPT - Model V5011ZL

Part No.	Size (in)	L (in)		WS (in)	
		1	2	Dec	Frac
46302	3/8 x 1/2 MPT	1.63	1 5/8	0.88	7/8
46321	1/2 x 1/2 MPT	1.65	1 5/8	0.88	7/8
46324	1/2 x 3/4 MPT	1.84	1 13/16	1.06	1 1/16
46342	3/4 x 1/2 MPT	1.68	1 11/16	0.88	7/8
46340	3/4 x 3/4 MPT	1.84	1 13/16	1.06	1 1/16
46446	3/4 x 1 MPT	2.07	2 1/16	1.38	1 3/8
46361	1 x 3/4 MPT	2.02	2	1.06	1 1/16
46366	1 x 1 MPT	2.25	2 1/4	1.38	1 3/8

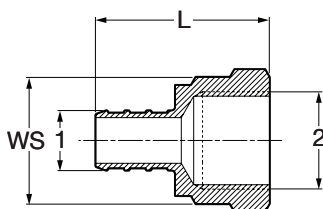
Viega PureFlow Crimp Adapter Zero Lead Brass Crimp x FPT - Model V5012ZL

Part No.	Size (in)	L (in)		WS (in)	
		1	2	Dec	Frac
46323	3/8 x 1/2 FPT	1.62	1 5/8	1.00	1
46333	1/2 x 1/2 FPT	1.62	1 5/8	1.00	1
46334	1/2 x 3/4 FPT	1.67	1 11/16	1.25	1 1/4
46344	3/4 x 3/4 FPT	1.67	1 11/16	1.25	1 1/4
46345	3/4 x 1 FPT	1.89	1 7/8	1.50	1 1/2
46355	1 x 1 FPT	2.07	2 1/16	1.50	1 1/2

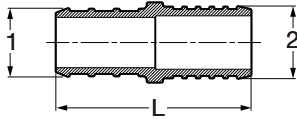
Viega PureFlow Crimp Adapter Zero Lead Brass Crimp x PB - Model V5017ZL

Part No.	Size (in)		L (in)	
	1	2	Dec	Frac
46620	3/8 x 3/8 PB		1.37	1 3/8
46630	1/2 x 1/2 PB		1.37	1 3/8
46145	3/4 x 3/4 PB		1.94	1 15/16
46156	1 x 1 PB		2.39	2 3/8

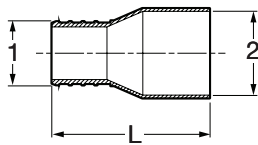
Viega PureFlow Crimp Adapter Zero Lead Brass Crimp x C - Model V5045ZL

Part No.	Size (in)		L (in)	
	1	2	Dec	Frac
46635	1/2 x 1/2 C		1.33	1 5/16
46645	3/4 x 3/4 C		1.57	1 9/16
40655	1 x 1 C		2.13	2 1/8

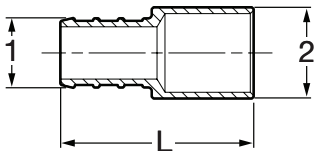
Viega PureFlow Crimp Adapter Zero Lead Brass Crimp x FTG - Model V5046ZL

Part No.	Size (in)		L (in)	
	1	2	Dec	Frac
46633	1/2 x 1/2 FTG		1.33	1 5/16
46644	3/4 x 3/4 FTG		1.50	1 1/2
60651	1 x 1 FTG		1.97	2

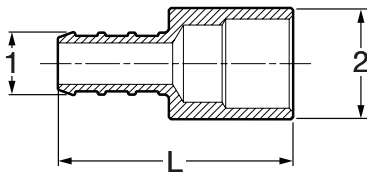
Viega PureFlow Crimp Adapter Zero Lead Brass Crimp x FTG x C - Model V5024ZL

Part No.	Size (in)		L (in)	
	1	2	Dec	Frac
46621	3/8 x 3/8 FTG or 1/4 C		1.33	1 5/16
46622	3/8 x 1/2 FTG or 3/8 C		1.33	1 5/16
46631	1/2 x 3/8 FTG or 1/4 C		1.46	1 7/16
46654	1 x 1 FTG or 3/4 C		1.92	1 15/16

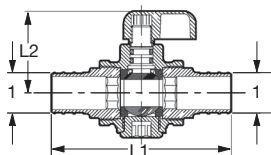
Viega PureFlow Crimp Ball Valve Zero Lead Brass 1/4 Turn - Model V5037ZL

Part No.	Size (in)		L1 (in)		L2 (in)	
	1	1	Dec	Frac	Dec	Frac
46010	3/8 x 3/8		3.09	3 1/16	1.20	1 3/16
46031	1/2 x 1/2		2.76	2 3/4	1.20	1 3/16
46044	3/4 x 3/4		2.95	2 15/16	1.30	1 5/16

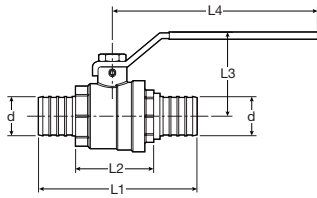
Viega PureFlow Crimp Ball Valve Zero Lead Brass ¼ Turn - Model V5037ZL

Part No.	Size (in)	L1 (in)		L2 (in)		L3 (in)		L4 (in)	
		Dec	Frac	Dec	Frac	Dec	Frac	Dec	Frac
46060	1 x 1	3.41	3 ⁷ / ₁₆	1.71	1 ¹¹ / ₁₆	1.84	1 ¹³ / ₁₆	4.50	4 ¹ / ₂

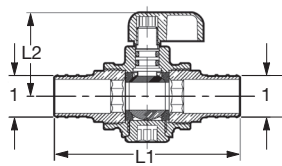
Viega PureFlow Crimp Ball Valve Zero Lead Chrome Plated Brass ¼ Turn - Model V5023ZL

Part No.	Size (in)	L1 (in)		L2 (in)	
		Dec	Frac	Dec	Frac
46021	½	2.76	2 ³ / ₄	1.20	1 ³ / ₁₆

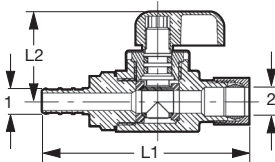
Viega PureFlow Crimp Stop Valve Straight Zero Lead Chrome Plated Brass Crimp x CTS ¼ Turn - Model V5026ZL

Part No.	Size (in)	L1 (in)		L2 (in)	
		Dec	Frac	Dec	Frac
46001	¾ x ¼ CTS (¾ OD) Comp	2.78	2 ³ / ₄	1.20	1 ³ / ₁₆
46022	½ x ¼ CTS (¾ OD) Comp	2.78	2 ³ / ₄	1.20	1 ³ / ₁₆

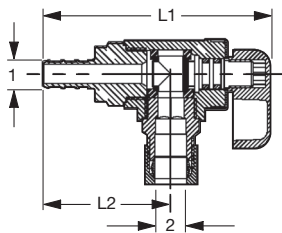
Viega PureFlow Crimp Stop Valve Angled Zero Lead Chrome Plated Brass Crimp x CTS ¼ Turn - Model V5064ZL

Part No.	Size (in)	L1 (in)		L2 (in)	
		Dec	Frac	Dec	Frac
46002	¾ x ¼ CTS (¾ OD) Comp	2.70	2 ¹¹ / ₁₆	1.03	1
46025	½ x ¼ CTS (¾ OD) Comp	2.80	2 ¹³ / ₁₆	1.03	1

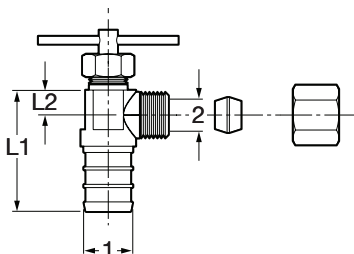
Viega PureFlow Crimp Adapter Straight Zero Lead Brass For Ice Maker Crimp x CTS - Model V5051ZL

Part No.	Size (in)	L1 (in)		L2 (in)	
		Dec	Frac	Dec	Frac
46301	¾ x ⅛ CTS (¼ OD) Comp	1.48	1 ¹ / ₂	0.55	⅝
46322	½ x ⅛ CTS (¼ OD) Comp	1.48	1 ¹ / ₂	0.55	⅝

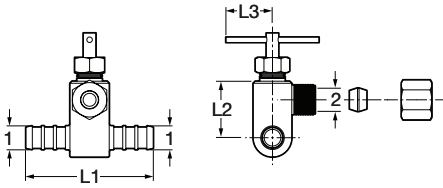
Viega PureFlow Crimp Tee Zero Lead Brass For Ice Maker Crimp x Crimp x CTS - Model V5062ZL

Part No.	Size (in)		L1 (in)		L2 (in)		L3 (in)	
	1	2	Dec	Frac	Dec	Frac	Dec	Frac
46503	3/8 x 1/8 CTS (1/4 OD)	Comp	1.83	1 ¹³ / ₁₆	1.03	1	0.59	9/ ₁₆
46521	1/2 x 1/8 CTS (1/4 OD)	Comp	1.83	1 ¹³ / ₁₆	1.03	1	0.59	9/ ₁₆

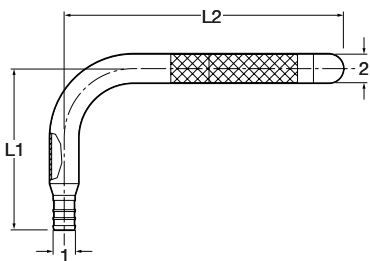
Viega PureFlow Crimp Stub-Out 90° Elbow Zero Lead Copper Crimp x Street - Model V5070

Part No.	Size (in)		L1 (in)		L2 (in)	
	1	2	Dec	Frac	Dec	Frac
44208	3/8 x 1/2 FTG		3.50	3 ¹ / ₂	7.75	7 ³ / ₄
44226	1/2 x 1/2 FTG		3.50	3 ¹ / ₂	5.75	5 ³ / ₄
44228	1/2 x 1/2 FTG		3.50	3 ¹ / ₂	7.75	6 ³ / ₄
44240	3/4 x 3/4 FTG		4.50	4 ¹ / ₂	8.00	8

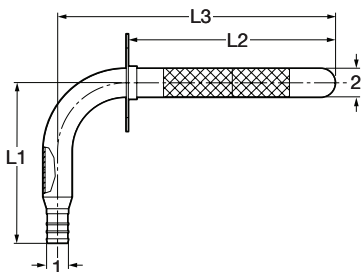
Viega PureFlow Crimp Stub-Out 90° Elbow Zero Lead Copper Crimp x Street with Wall Plate - Model V5070.1

Part No.	Size (in)		L1 (in)		L2 (in)		L3 (in)	
	1	2	Dec	Frac	Dec	Frac	Dec	Frac
44209	3/8 x 1/2 FTG		3.50	3 ¹ / ₂	7.75	7 ³ / ₄	6.00	6
44227	1/2 x 1/2 FTG		3.50	3 ¹ / ₂	5.75	5 ³ / ₄	4.00	4
44229	1/2 x 1/2 FTG		3.50	3 ¹ / ₂	7.75	7 ³ / ₄	6.00	6

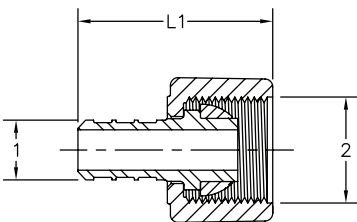
Viega PureFlow Crimp Lav Adapter Zero Lead Brass Crimp x Lav - Model V5075ZL

Part No.	Size (in)		L (in)	
	1	2	Dec	Frac
46023	3/8 x 1/2 Lav	(plastic nut)	1.65	1 ⁵ / ₈
46033	1/2 x 1/2 Lav	(plastic nut)	1.65	1 ⁵ / ₈
46024	3/8 x 1/2 Lav	(brass nut)	1.65	1 ⁵ / ₈
46034	1/2 x 1/2 Lav	(brass nut)	1.65	1 ⁵ / ₈
46040	3/4 x 3/4 Lav	(brass nut)	1.70	1 ¹¹ / ₁₆

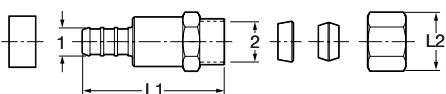
Viega PureFlow Crimp Lav Adapter Zero Lead Brass Crimp x CTS - Model V5077ZL

Part No.	Size (in)		L1 (in)		L2 (in)	
	1	2	Dec	Frac	Dec	Frac
46032	3/8 x 1/4 CTS (3/8 OD)	Comp	1.76	1 ³ / ₄	0.63	5/ ₈
46331	1/2 x 1/4 CTS (3/8 OD)	Comp	1.76	1 ³ / ₄	0.63	5/ ₈

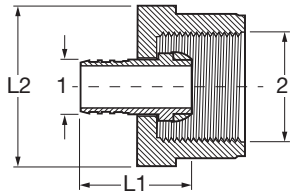
Viega PureFlow Crimp Closet Adapter Zero Lead Brass Crimp x Closet - Model V5072ZL

Part No.	Size (in) 1 2	L1 (in)		L2 (in)	
		Dec	Frac	Dec	Frac
46223	3/8 x 1/2 Closet (plastic nut)	1.36	1 3/8	1.16	1 3/16
46234	1/2 x 1/2 Closet (plastic nut)	1.36	1 3/8	1.16	1 3/16

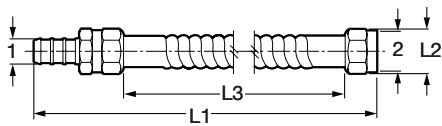
Viega PureFlow Crimp Swivel Connector Zero Lead Copper For Water Heater Crimp x FPT - Model V5048ZL

Part No.	Size (in) 1 2	L1 (in)		L2 (in)		L3 (in)	
		Dec	Frac	Dec	Frac	Dec	Frac
46764	3/4 x 3/4 FPT	19.00	19	1.13	1 1/8	18.00	18

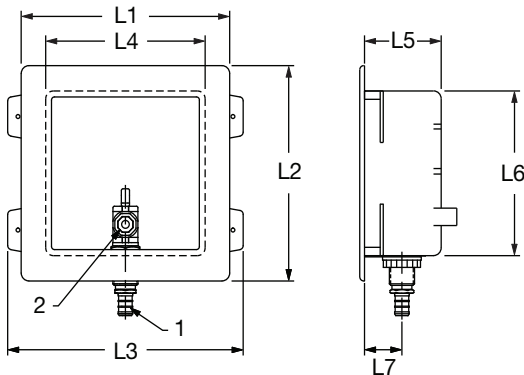
Viega PureFlow Crimp Outlet Box Zero Lead Brass For Ice Maker 1/4 Turn - Model 2872ZL

Part No.	Size (in) 1 2	L1 (in)		L2 (in)		L3 (in)		L4 (in)		L5 (in)		L6 (in)		L7 (in)	
		Dec	Frac	Dec	Frac	Dec	Frac	Dec	Frac	Dec	Frac	Dec	Frac	Dec	Frac
46710*	3/8 x 1/8 CTS (1/4 O.D.)	6.80	6 13/16	6.80	6 13/16	7.68	7 11/16	5.20	5 3/16	2.50	2 1/2	5.20	5 3/16	1.22	1 1/4
46720*	1/2 x 1/8 CTS (1/4 O.D.)	6.80	6 13/16	6.80	6 13/16	7.68	7 11/16	5.20	5 3/16	2.50	2 1/2	5.20	5 3/16	1.22	1 1/4
43700	3/8 x 1/8 CTS (1/4 O.D.)	6.80	6 13/16	6.80	6 13/16	7.68	7 11/16	5.20	5 3/16	2.50	2 1/2	5.20	5 3/16	1.22	1 1/4
43722	1/2 x 1/8 CTS (1/4 O.D.)	6.80	6 13/16	6.80	6 13/16	7.68	7 11/16	5.20	5 3/16	2.50	2 1/2	5.20	5 3/16	1.22	1 1/4

* with hammer arrestor

Viega PureFlow Crimp Outlet Box Zero Lead Brass For Washing Machine ¼ Turn - Model 2872.9ZL

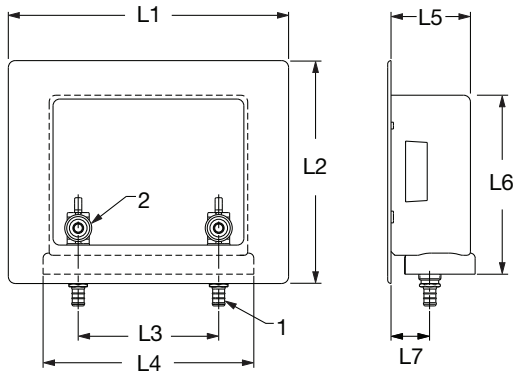

Part No.	Size (in) 1 2	L1 (in)		L2 (in)		L3 (in)		L4 (in)		L5 (in)		L6 (in)		L7 (in)	
		Dec	Frac	Dec	Frac	Dec	Frac	Dec	Frac	Dec	Frac	Dec	Frac	Dec	Frac
46730*	½ x ¾ Hose	10.40	10 ³ / ₈	8.30	8 ⁵ / ₁₆	5.20	5 ³ / ₁₆	7.40	7 ³ / ₈	2.90	2 ⁷ / ₈	6.60	6 ⁵ / ₈	1.43	1 ⁷ / ₁₆
43720	½ x ¾ Hose	10.40	10 ³ / ₈	8.30	8 ⁵ / ₁₆	5.20	5 ³ / ₁₆	7.40	7 ³ / ₈	2.90	2 ⁷ / ₈	6.60	6 ⁵ / ₈	1.43	1 ⁷ / ₁₆

* with hammer arrestor

Viega PureFlow Crimp Ring Copper - Model V5019.9

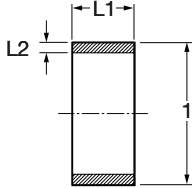

Part No.	Size (in) 1	L1 (in)		L2 (in)	
		Dec	Frac	Dec	Frac
43600	3/8	0.32	5/16	0.05	1/16
43620	1/2	0.32	5/16	0.05	1/16
43640	3/4	0.32	5/16	0.05	1/16
43660	1	0.36	3/8	0.04	1/16