

Connected in quality.

VIEGA MEGAPRESS[®] SYSTEMS

POCKET GUIDE



viega.us

viega

Viega.

Connected in quality.

Building on Tradition

Founded 125 years ago, Viega is a privately owned international group of companies. In the United States, Canada, Mexico, and Latin America, Viega specializes in plumbing, heating, and pipe-joining technologies. The values of Viega's founder, Franz-Anselm Viegener, are just as present today as they were when he started the company in 1899. Courage, passion, and innovative spirit are still the basics of Viega's foundation.

At Viega, Safety Is Priority.

Safe, certain, and secure, Viega fittings are designed for peace of mind

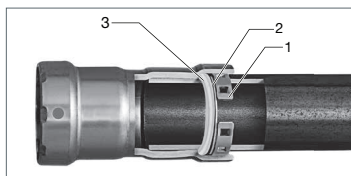

1. In MegaPress, MegaPress FKM, and MegaPressG fittings, the 420 stainless steel grip ring's teeth cut into the pipe and lock the fitting securely in place.

2. For ½" to 2" fittings, a 304 stainless steel separator ring protects the sealing element from damage by creating a positive physical separation during installation. For 2½" to 4" fittings, a PBT (Polybutylene Terephthalate) separator ring for MegaPress and MegaPress FKM fittings and a graphite separator ring for MegaPressG protects the sealing element.
3. Viega offers three different sealing elements to suit virtually any application: EPDM, HNBR, and FKM. They all ensure watertight or airtight connections.

In all MegaPress fittings, Viega's unique Smart Connect technology helps installers ensure that they have pressed all connections.



This document is subject to updates. For the most current Viega technical literature, please visit www.viega.us.



A green dot on a Viega MegaPress fitting indicates Smart Connect® technology with an EPDM sealing element. A white dot on a Viega MegaPress FKM fitting indicates Smart Connect technology with an FKM sealing element. A yellow dot on a Viega MegaPressG fitting indicates Smart Connect technology with an HNBR sealing element. For a current list of applications, please see the [Applications Chart](#).

Introduction	4
MegaPress, MegaPress FKM, and MegaPressG Systems	4
System Data	6
Viega MegaPress ½" to 2" Fittings	6
Viega MegaPress FKM Fittings	7
Viega MegaPressG Fittings	8
Tech Data	9
Viega MegaPress Ball Valve, Model 4870	9
Viega MegaPress FKM Ball Valve, Models 5970 and 5970XL	10
Viega MegaPress 3-Piece Ball Valve, Model 4875.8	11
Viega MegaPress FKM 3-Piece Ball Valve, Models 5975.8, 5975.8XL	12
Viega MegaPressG Ball Valve, Model 6675	13
Viega MegaPressG Ball Valve, Model 6675XL	14
Viega MegaPressG Ball Valve, Model 6675.1	15
Viega MegaPressG Ball Valve, Model 6675.2	16
Viega MegaPressG Ball Valve, Model 6675.3	17
Product Instructions	19
Viega MegaPress ½" to 2" Fittings	19
Viega MegaPress 2½" to 4" Fittings	20
Technical Information	22
Approved Applications	22
Sealing Element Description	24
Viega MegaPress Pipe Marking Guide	25
No-Stop Couplings	26
Welding	26
Minimum Distance Between MegaPress Connections	26
General Installation Notes	27
Deflection	28
Viega MegaPress Pipe Preparation Guide	29
Tool Clearances	30
Pressing with Ring and Actuator in Tight Quarters	32
Dimensional Documentation	33
MegaPress Fittings	33
Frequently Asked Questions	48
Limited Warranty	49
Viega MegaPress Limited Warranty	49
Viega MegaPressG Limited Warranty	50
Viega Metal Systems for Industrial Applications Limited Warranty	51



Viega products are designed to be installed by licensed and trained plumbing and mechanical professionals who are familiar with Viega products and their installation. **Installation by non-professionals may void Viega LLC's warranty.**

MegaPress, MegaPress FKM, and MegaPressG Systems

Viega MegaPress systems are state-of-the-art Iron Pipe Size (IPS) press fitting systems that provide an economical and reliable installation of schedule 5 to schedule 40 carbon steel pipes.

Viega MegaPressG fittings for fuel gas or fuel oil systems shall be used with ASTM A53 schedule 10 and schedule 40 carbon steel pipe. MegaPressG is ANSI LC-4/CSA 6.32 approved for fuel gas installations.

Viega MegaPress fittings and valves are constructed of carbon steel with a corrosion-resistant zinc nickel coating ranging from 1/2" to 2" for MegaPress and 1/2" to 4" for MegaPress FKM and MegaPressG.

The Viega MegaPress fitting system is offered in configurations that allow for the installation of the vast majority of carbon steel piping applications in the residential, commercial, and industrial markets. MegaPress fittings may be used with seamless (S) or longitudinal welded (W) steel pipes.

MegaPress fittings feature a green dot with an EPDM sealing element while MegaPress FKM fittings have a white dot with an FKM sealing element. MegaPressG fittings have a yellow dot with an HNBR sealing element. All use Viega's unique Smart Connect technology to help installers ensure that they have pressed all connections.

MegaPress 1/2" to 2" fittings with an EPDM sealing element and MegaPress FKM 2 1/2" to 4" fittings may be installed in NFPA 13, 13R, and 13D fire sprinkler systems. They are certified for use in "wet" and "dry" fire protection systems in accordance with UL and FM certifications:

- ANSI/CAN/UL 213: Standard for Rubber Gasketed Fittings for Fire-Protection Services.
- FM Class 1920: Pipe Couplings and Fittings for Aboveground Fire Protection Systems.

Viega MegaPress systems can help reduce installation time by up to 90 percent compared to traditional methods of pipe joining. Threading and welding can be messy and time consuming, and connections are not always reliable. With Viega press technology, installers can make consistent, secure press connections in a matter of seconds without flame or heavy equipment.

The fittings require no soldering or welding and are installed with electrohydraulic press tools (battery-powered or corded press tools).

Viega MegaPress fittings can be utilized for a wide variety of applications in industrial, commercial, or residential projects.



It is the responsibility of the installer or any other parties to adhere to all applicable local rules and regulations governing the nature of the installation.



The use of the system for applications other than those listed or outside of these parameters must be approved by Viega Technical Support (techsupport@viega.us).

Smart Connect Technology – Security Under Pressure

Locating unpressed connections is an important step in the pressure-testing process. Viega MegaPress fittings include Smart Connect technology, providing quick and easy identification of unpressed connections during a pressure test.

Smart Connect technology is a design of the fitting, providing a path for liquids and/or gases from inside the system past the sealing element of an unpressed connection. When pressed according to our Product Instructions, the fluid path is altered, creating a reliable, leakproof connection.

Unpressed connections are located by pressurizing the system with air or water. When testing with water, the proper pressure range is 15 to 85 psi. Pressure testing with air can be dangerous at high pressures. When testing with compressed air, the proper pressure range is ½ to 45 psi. Following a successful Smart Connect test, the system may be pressure tested up to 600 psi maximum for water and 200 psi maximum for air if required by local code requirements.

i Testing for unpressed connections using Smart Connect is not a replacement for pressure-testing requirements of local codes and standards.



1 Identify an unpressed connection during pressure testing when water flows past the sealing element.

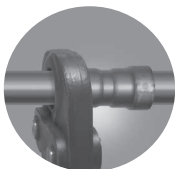

2 Upon identification, use the press tool to press the fitting, making a secure, leakproof connection.

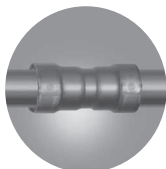

3 Viega MegaPress connections are fast, flameless, and reliable.



DANGER!

Read and understand all instructions for installing Viega MegaPress fittings. Failure to follow all instructions may result in extensive property damage, serious injury, or death.

Viega MegaPress ½" to 2" Fittings

MegaPress is a carbon steel, cold press system designed for use in chilled water, hydronic heating, compressed air, and fire sprinkler applications.

MegaPress fittings in sizes from ½" to 2" are offered in configurations that include elbows, couplings, no-stop couplings, reducers, tees, reducing tees, adapters, reducing adapters, unions, caps, and flanges.

Components

- Alloy: carbon steel with corrosion-resistant zinc nickel coating
- EPDM sealing element
- 420 stainless steel grip ring
- 304 stainless steel separator ring

Operating Parameters

- Operating Pressure: 200 psi max
- Test Pressure: 600 psi max
- Operating Temperatures: 0°F to 250°F

Listings and Certificates

- ANSI/CAN/UL 213
- FM Class 1920
- ASTM F3226
- IAPMO/ANSI/
- CRN 23019.5
- CAN Z1117
- A/B/C
- ICC LC1002

Compliant With

- ASME B31, B31.1, B31.3, B31.9
- IAPMO Uniform Mechanical Code (UMC)
- ICC International Mechanical Code (IMC)
- ICC International Residential Code (IRC)
- National Building Code of Canada (NBCC)
- National Plumbing Code of Canada (NPCC)
- NFPA 13, 13D, 13R

Approved Applications

- Hydronics
- Compressed air (no oil)
- Low-pressure steam
- Fire sprinkler
- Industrial gases
- Vacuum

MegaPress fittings with an EPDM seal are not approved for potable water or fuel gas applications. For more specific information on applications for MegaPress, contact Viega Technical Support at 1-800-976-9819.

MegaPress ½" to 2" systems are approved for underground use and must be protected against corrosion in accordance with NFPA 54 section 404.8, NACE Standard RP0169-2002 section 5, 2009 UPC Chapter 6 section 609.3.1, 2009 UMC Chapter 13 section 1312.1.3, and in accordance with local and national codes.

MegaPress fittings are designed for use in piping systems utilizing ASTM A53, A106, A135, and A795 Schedule 5 to Schedule 40 carbon steel pipe.

Recommended Tools

- Standard-size press tool (minimum hydraulic ram output of 7,200 lbs.)
- #56013 MegaPress jaw/ring kit

Smart Connect Technology

MegaPress fittings are manufactured with Viega's unique Smart Connect technology. A design of the fitting, Smart Connect technology allows identification of an unpressed fitting during pressure testing.

Viega MegaPress FKM Fittings

MegaPress FKM is a carbon steel, cold press system designed for use in chilled water, hydronic heating, compressed air, and fire sprinkler applications.

MegaPress FKM fittings in sizes from ½" to 4" are offered in configurations that include elbows, couplings, no-stop couplings, reducers, tees, reducing tees, adapters, unions, caps, and flanges.

Components

- Alloy: carbon steel with corrosion-resistant zinc nickel coating
- FKM sealing element
- 420 stainless steel grip ring
- 304 stainless steel separator ring for ½" to 2" fittings
- PBT separator ring for 2½" to 4" fittings

Operating Parameters

- Operating Pressure: 200 psi max
- Test Pressure: 600 psi max
- Operating Temperatures: 14°F to 284°F (with temperature spikes up to 356°F)

Listings and Certificates

- ANSI/CAN/UL 213
- ASTM F3226
- CRN 23019.5
- IAPMO/ANSI/ CAN Z1117
- ICC LC1002
- FM Class 1920
- A/B/C

Compliant With

- ASME B31, B31.1, B31.3, B31.9
- IAPMO Uniform Mechanical Code (UMC)
- ICC International Mechanical Code (IMC)
- ICC International Residential Code (IRC)
- National Building Code of Canada (NBCC)
- National Plumbing Code of Canada (NPCC)
- NFPA 13, 13D, 13R

Approved Applications

- Fire sprinkler
- Hydronics
- Low-pressure steam
- Fuel oil
- Industrial gases
- Compressed air
- Vacuum

MegaPress FKM is not approved for potable water application. For more specific information on applications for MegaPress FKM, contact Viega Technical Support at 1-800-976-9819.

MegaPress FKM systems are approved for underground use and must be protected against corrosion in accordance with NFPA 54 section 404.8, NACE Standard RP0169-2002 section 5, 2009 UPC Chapter 6 section 609.3.1, 2009 UMC Chapter 13 section 1312.1.3, and in accordance with local and national codes.

MegaPress FKM fittings are designed for use in piping systems utilizing ASTM A53, A106, A135, and A795 Schedule 5 to Schedule 40 carbon steel pipe.

Recommended Tools

- Standard-size press tool (minimum hydraulic ram output of 7,200 lbs.)
- #56013 MegaPress jaw/ring kit (½" to 2")
- #26200 MegaPress XL PressBooster with 2½" press ring
- #57078 MegaPress XL 3" and 4" press ring kit
- #57081 Z3 Actuator with 2½" press ring (must be used with press gun with minimum 80mm press stroke)

Smart Connect Technology

MegaPress FKM fittings are manufactured with Viega's unique Smart Connect technology. A design of the fitting, Smart Connect technology allows identification of an unpressed fitting during pressure testing.

Viega MegaPressG Fittings

Viega MegaPressG is a carbon steel, cold press fitting system designed for use in fuel gas systems and applications with a high oil content. MegaPressG fittings in sizes from ½" to 4" are offered in numerous configurations.

Components

- Alloy: carbon steel with corrosion-resistant zinc nickel coating
- HNBR sealing element
- 420 stainless steel grip ring
- 304 stainless steel separator ring for ½" to 2" fittings
- Graphite separator ring for 2½" to 4" fittings

Operating Parameters

- Operating Pressure:
 - 125 psi max for fuel gas applications
 - 200 psi max for other approved applications
- Test Pressure: 200 psi max air, 600 psi max water
- Operating Temperatures: -40°F to 180°F

Approved Piping

- Fuel gas applications: ASTM A53 Schedule 10 to Schedule 40 carbon steel pipe
- Non-fuel gas applications: ASTM A53, A106, A135, and A795 Schedule 5 to Schedule 40 carbon steel pipe. Schedule 80 pipe may be used, but operating pressures are limited to those in Viega's [Applications Chart](#).



Adopted code versions, standards compliance, and local approvals should be considered for selecting pipe schedule and type.

Listings and Certifications

- ANSI/CAN/UL/ULC 180
- ASTM F3226
- CRN 23019.5 A/B/C
- CSA: ANSI LC 4a/CSA 6.32a
- IAPMO: ANSI LC 4a/CSA 6.32a
- ICC-ES: ANSI LC 4a/CSA 6.32a



ANSI/CAN/UL/ULC 180 Standard for Safety for Combustible Liquid Tank Accessories: Compression Fittings for Aboveground Pipe Supply and Fill Vents. Install according to the

Manufacturer's Instructions. For Combustible Liquid Use. Pressure rating max 125 psi / 861 kPa. Fire rating 30 minutes.

Compliant With

- ASME B31, B31.1, B31.3, B31.9
- CAN/CSA-B149.1
- IAPMO National Standard Plumbing Code (NSPC)
- IAPMO Uniform Mechanical Code (UMC)
- IAPMO Uniform Plumbing Code (UPC)
- ICC International Fuel Gas Code (IFGC)
- ICC International Residential Code (IRC)
- NFPA 54/Z223: National Fuel Gas Code
- NFPA 58: Liquefied Petroleum Gas Code

Approved Applications

- Natural gas
- Propane gas
- Lubricants/oils
- Compressed air
- Industrial gases
- Vacuum

For more specific information on applications for MegaPressG, contact Viega Technical Support at 1-800-976-9819.

Viega MegaPressG systems are approved for underground use and must be protected against corrosion in accordance with NFPA 54 section 404.8, NACE Standard RP0169-2002 section 5, 2009 UPC Chapter 6 section 609.3.1, 2009 UMC Chapter 13 section 1312.1.3, and in accordance with local and national codes.

Recommended Tools

- Standard-size press tool (minimum hydraulic ram output of 7,200 lbs.)
- #56013 MegaPress jaw/ring kit (½" to 2")
- #26200 MegaPress XL PressBooster with 2½" press ring
- #57078 MegaPress XL 3" and 4" press ring kit
- #57081 Z3 Actuator with 2½" press ring (must be used with press gun with minimum 80mm press stroke)

Smart Connect Technology

Viega MegaPressG fittings are manufactured with Viega's unique Smart Connect technology. A design of the fitting, Viega Smart Connect technology allows identification of an unpressed fitting during pressure testing.

Viega MegaPress Ball Valve, Model 4870

The MegaPress carbon steel ball valve is equipped with a full port, zinc-nickel-coated carbon steel body and press ends. The ball valve features an EPDM sealing element, a 420 stainless steel grip ring, a 304 stainless separator ring, EPDM stem seals, a locking metal handle, and Viega's Smart Connect technology for easy identification of unpressed connections during pressure testing.

Features

- 316 stainless steel ball
- Body material designation: CS 1.0553
- Eco Brass® blowout-proof stem
- Lockable metal handle
- Reinforced PTFE seats
- Smart Connect technology

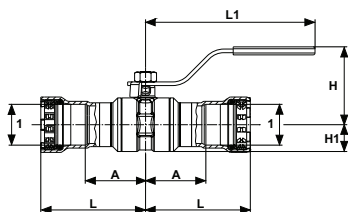

Ratings

- Temperature Range: 0°F to 250°F
- Max. Operating Pressure: 250 CWP

Approvals

- Conforms to MSS SP-110
- ASME B31
- IAPMO/ANSI Z1157

Recommended Tools

- Standard-size press tool (minimum hydraulic ram output of 7,200 lbs.)
- #56013 MegaPress jaw/ring kit

Part No.	Size (in)	A (in)	L (in)	L1 (in)	H (in)	H1 (in)
	1					
28915	½	1.535	2.618	4.567	1.992	0.634
28920	¾	1.638	2.795	4.567	2.102	0.748
28925	1	1.811	3.157	5.768	2.469	0.878
28930	1¼	1.976	3.795	5.768	2.709	1.142
28935	1½	2.142	4.012	6.122	3.016	1.358
28940	2	2.382	4.370	6.122	3.315	1.654

Valve Size (in)	Valve Stem Nut Size	Stem Nut ft/lbs	Stem Nut (Nm)	Cv (US gal/min)
½	M8	3.7 to 7.5	5 to 10	15.5
¾	M8	3.7 to 7.5	5 to 10	33.4
1	M8	3.7 to 7.5	5 to 10	46.4
1¼	M8	3.7 to 7.5	5 to 10	93.5
1½	M8	3.7 to 7.5	5 to 10	124
2	M8	3.7 to 7.5	5 to 10	246

Viega MegaPress FKM Ball Valve, Models 5970 and 5970XL

The MegaPress FKM carbon steel ball valve is equipped with a full port, zinc-nickel-coated carbon steel body and press ends. The ball valve features an FKM sealing element, a 420 stainless steel grip ring, a 304 stainless separator ring, FKM stem seals, a locking metal handle, and Viega's Smart Connect technology for easy identification of unpressed connections during pressure testing.

Features

- 316 stainless steel ball
- Body material designation: CS 1.0553
- Eco Brass blowout-proof stem
- Lockable metal handle
- Reinforced PTFE seats
- Smart Connect technology
- ISO 5211 mounting pad (for 2½", 3", and 4" only)

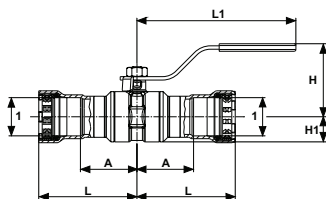

Part No.	Size (in)	A (in)	L (in)	L1 (in)	H (in)	H1 (in)
FKM 1	1					
28945	½	1.535	2.618	4.567	1.992	0.634
28950	¾	1.638	2.795	4.567	2.102	0.748
28955	1	1.811	3.157	5.768	2.469	0.878
28960	1¼	1.976	3.795	5.768	2.709	1.142
28965	1½	2.142	4.012	6.122	3.016	1.358
28970	2	2.382	4.370	6.122	3.315	1.654
86790	2½	3.720	5.520	11.09	5.130	2.390
86795	3	4.070	6.400	11.09	5.520	2.800
86800	4	4.670	7.840	13.06	6.700	3.450

Ratings

- Temperature Range: 14°F to 284°F (with temperature spikes up to 365°F)
- Max. Operating Pressure ½" to 2": 250 CWP
- Max. Operating Pressure 2½" to 4": 200 CWP

Approvals

- Conforms to MSS SP-110
- ASME B31
- APMO/ANSI Z1157

Recommended Tools

For ½" to 2":

- Standard-size press tool (minimum hydraulic ram output of 7,200 lbs.)
- #56013 MegaPress jaw/ring kit (½" to 2")

For 2½" to 4":

- Standard-size press tool (minimum hydraulic ram output of 7,200 lbs.) for use with the PressBooster
- #26200 MegaPress XL PressBooster with 2½" press ring
- #57078 MegaPress XL 3" and 4" press ring kit
- #57081 Z3 Actuator with 2½" press ring (must be used with press gun with minimum 80mm press stroke)

Valve Size (in)	Valve Stem Nut Size	Stem Nut ft/lbs	Stem Nut (Nm)	Cv (US gal/min)
½	M8	3.7 to 7.5	5 to 10	15.5
¾	M8	3.7 to 7.5	5 to 10	33.4
1	M8	3.7 to 7.5	5 to 10	46.4
1¼	M8	3.7 to 7.5	5 to 10	93.5
1½	M8	3.7 to 7.5	5 to 10	124
2	M8	3.7 to 7.5	5 to 10	246
2½	M8	22.1 to 44.3	30 to 60	403
3	M8	22.1 to 44.3	30 to 60	606
4	M8	22.1 to 44.3	30 to 60	1,049

Viega MegaPress 3-Piece Ball Valve, Model 4875.8

The MegaPress EPDM 3-piece carbon steel ball valve is equipped with a full port, 316 stainless steel 3-piece body, and zinc-nickel-coated steel press ends. The ball valve features an EPDM sealing element, a 420 stainless grip ring, a 304 stainless separator ring, PTFE stem seals, a locking metal handle, and Viega's Smart Connect technology for easy identification of unpressed connections during pressure testing.

Recommended Tools

- Standard-size press tool (minimum hydraulic ram output of 7200 lbs.)
- #56013 MegaPress jaw/ring kit

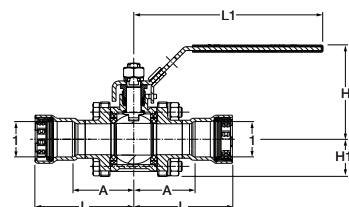

Features

- 316 stainless steel ball
- Blowout-proof 316 stainless steel stem
- 304 stainless steel locking handle
- Adjustable packing nut
- Reinforced PTFE seats
- Smart Connect technology
- ISO 5211 mounting pad

Ratings

- Temperature Range: 0°F to 250°F
- Max. Operating Pressure: 250 CWP

Approvals

- Conforms to MSS SP-110
- ASME B31
- IAPMO Z1157

Part No.	Size (in)	A (in)	L (in)	L1 (in)	H (in)	H1 (in)
	1					
28500	½	1.72	2.80	5.88	2.85	1.04
28501	¾	1.91	3.06	5.88	2.93	1.16
28502	1	2.19	3.54	7.54	3.33	1.40
28503	1¼	2.50	4.31	7.54	3.57	1.57
28504	1½	2.92	4.79	7.54	3.89	1.83
28505	2	3.09	5.07	7.54	3.89	1.83

Valve Size (in)	Valve Body Bolt & Nut Size		Bolt Torque +/- 5		Valve Stem Nut Size	Stem Nut	
			ft/lbs	(Nm)		ft/lbs	(Nm)
½	M8 x 55	M8	7.5	(10)	AF 16 mm	7.5	10
¾	M8 x 65	M8	15	(20)	AF 18 mm	11	15
1	M10 x 75	M10	15	(20)	AF 21 mm	11	15
1¼	M10 x 90	M10	22.5	(30)	AF 22 mm	18.5	25
1½	M10 x 100	M10	22.5	(30)	AF 24 mm	18.5	25
2	M10 x 100	M10	22.5	(30)	AF 24 mm	18.5	25

Viega MegaPress FKM 3-Piece Ball Valve, Models 5975.8, 5975.8XL

The MegaPress FKM 3-piece carbon steel ball valve is equipped with a full port, 316 stainless steel 3-piece body and zinc-nickel-coated steel press ends. The ball valve features an FKM sealing element, a 420 stainless grip ring, a 304 stainless separator ring, PTFE stem seals, a locking metal handle, and Viega's Smart Connect technology for easy identification of unpressed connections during pressure testing.

Features

- 316 stainless steel ball
- Blowout-proof 316 stainless steel stem
- 304 stainless steel locking handle
- Adjustable packing nut
- Reinforced PTFE seats
- Smart Connect technology
- ISO 5211 mounting pad

Ratings

- Operating Temperatures: 14°F to 284°F (with temperature spikes up to 356°F)
- Max. Operating Pressure ½" to 2": 250 CWP
- Max. Operating Pressure 2½" to 4": 200 CWP

Valve Size (in)*	Valve Body Bolt & Nut Size		Bolt Torque +/- 5		Valve Stem Nut Size	Stem Nut	
			ft/lbs	(Nm)		ft/lbs	(Nm)
½	M8 x 55	M8	7.5	(10)	AF 16 mm	7.5	10
¾	M8 x 65	M8	15	(20)	AF 18 mm	11	15
1	M10 x 75	M10	15	(20)	AF 21 mm	11	15
1¼	M10 x 90	M10	22.5	(30)	AF 22 mm	18.5	25
1½	M10 x 100	M10	22.5	(30)	AF 24 mm	18.5	25
2	M10 x 100	M10	22.5	(30)	AF 24 mm	18.5	25
2½	M12 x 140	M14	45	(60)	AF 30 mm	26	(35)
3	M12 x 140	M14	45	(60)	AF 30 mm	26	(35)
4	M12 x 140	M14	45	(60)	AF 30 mm	26	(35)

*Sizes up to 3" have 4-bolt flanges; 4" has 6-bolt flanges.

Approvals

- Conforms to MSS SP-110
- ASME B31
- IAPMO Z1157

Recommended Tools

For ½" to 2":

- Standard-size press tool (minimum hydraulic ram output of 7,200 lbs.)
 - #56013 MegaPress jaw/ring kit (½" to 2")
- For 2½" to 4":

- Standard-size press tool (minimum hydraulic ram output of 7,200 lbs.) for use with the PressBooster
- #26200 MegaPress XL PressBooster with 2½" press ring
- #57078 MegaPress XL 3" and 4" press ring kit
- #57081 Z3 Actuator with 2½" press ring (must be used with press gun with minimum 80mm press stroke)

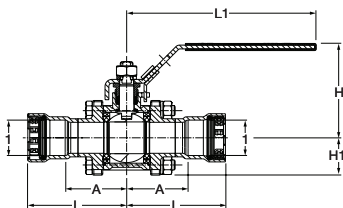

Part No.	Size (in)*	A (in)	L (in)	L1 (in)	H (in)	H1 (in)
EPDM FKM 1						
28500 86400	½	1.72	2.80	5.88	2.85	1.04
28501 86405	¾	1.91	3.06	5.88	2.93	1.16
28502 86410	1	2.19	3.54	7.54	3.33	1.40
28503 86415	1¼	2.50	4.31	7.54	3.57	1.57
28504 86420	1½	2.92	4.79	7.54	3.89	1.83
28505 86425	2	3.09	5.07	7.54	3.89	1.83
NA 86680	2½	3.74	5.54	11.06	5.08	2.28
NA 86685	3	4.37	6.67	11.06	5.47	2.68
NA 86690	4	4.88	8.06	13.07	6.89	3.79

*Sizes up to 3" have 4-bolt flanges; 4" has 6-bolt flanges.

Viega MegaPressG Ball Valve, Model 6675

The MegaPressG ball valve, model 6675, comes equipped with a full port silicon bronze body, a 316 stainless steel ball, and zinc-nickel-coated steel press ends. The ball valve is P x P and features an HNBR sealing element, a 420 SST grip ring, a 304 separator ring, and Viega's Smart Connect technology for easy identification of unpressed connections during pressure testing.

Features

- 316 stainless steel ball
- Lockable metal handle
- Double stem seal
- Reinforced PTFE seats
- Smart Connect technology

Ratings

- Temperature Range: -40°F to 180°F
- Max. Operating Pressure: 125 psi for fuel gas applications, 250 psi for other approved applications (see Viega's [Application Chart](#))

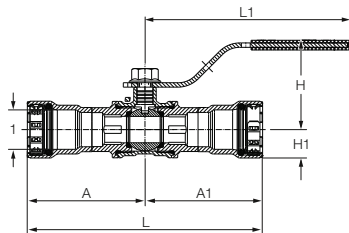

Approvals

- Conforms to MSS SP-110
- ANSI LC 4/CSA 6.32
- ANSI LC 4a/CSA 6.32a
- ASME B31

Recommended Tools

- Standard-size press tool (minimum hydraulic ram output of 7,200 lbs.)
- #56013 MegaPress jaw/ring kit

Component	Material
Body	Bronze C87700
Ball	316 Stainless Steel
Seat	Reinforced PTFE
Stem Seals	FKM or HNBR
Nut	Zinc-Plated Steel
Handle	Zinc-Plated Steel
Handle Cover	Polyvinyl
Sealing Element	HNBR
Connection Ends	Zinc-Nickel-Coated Steel
Grip Ring	420 Stainless Steel
Separator Ring	304 Stainless Steel

Part No.	Size (in)	A (in)	A1 (in)	L (in)	L1 (in)	H (in)	H1 (in)
	1						
30600	½	2.62	2.62	5.24	4.57	1.99	0.63
30605	¾	2.80	2.80	5.59	4.57	2.10	0.77
30610	1	3.16	3.16	6.31	5.77	2.46	0.91
30615	1¼	3.78	3.78	7.55	5.77	2.69	1.14
30620	1½	3.98	3.98	7.97	6.12	3.02	1.36
30625	2	4.35	4.35	8.70	6.12	3.31	1.65

Viega MegaPressG Ball Valve, Model 6675XL

The MegaPressG ball valve comes equipped with a full port zinc-nickel-coated carbon steel body, press ends, and a plated ball. The ball valve is P x P and features an HNBR sealing element, a 420 SST grip ring, a graphite separator ring, and Viega's Smart Connect® technology for easy identification of unpressed connections during pressure testing.

Features

- Chromium-plated ball
- Lockable stainless steel handle
- Double stem HNBR seal
- Reinforced PTFE seats
- Smart Connect technology

Ratings

- Temperature Range: -40°F to 180°F
- Max. Operating Pressure: 125 psi for fuel gas applications, 250 psi for other approved applications (see Viega's [Application Chart](#))

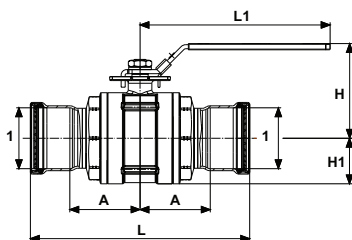

Approvals

- Conforms to MSS SP-110
- ANSI LC 4/CSA 6.32
- ANSI LC 4a/CSA 6.32a
- ASME B31

Recommended Tools

- Standard-size press tool (minimum hydraulic ram output of 7,200 lbs.) for use with the PressBooster
- #26200 MegaPress XL PressBooster with 2½" press ring
- #57078 MegaPress XL 3" and 4" press ring kit
- #57081 Z3 Actuator with 2½" press ring (must be used with press gun with minimum 80mm press stroke)

Component	Material
Body	Zinc-Nickel-Coated Steel
Ball	Low Lead Brass Chromium Plated
Seat	Reinforced PTFE
Stem Seals	HNBR
Nut	Stainless Steel
Handle	Stainless Steel
Handle Cover	Polyvinyl
Sealing Element	HNBR
Connection Ends	Zinc-Nickel-Coated Steel
Grip Ring	420 Stainless Steel
Separator Ring	304 Stainless Steel

Part No.	Size (in)	A (in)	L (in)	L1 (in)	H (in)	H1 (in)
	1					
86840	2½	3.72	11.04	11.09	5.14	2.40
86845	3	4.07	12.80	11.09	5.54	2.80
86850	4	4.67	15.68	13.06	6.70	3.45

Viega MegaPressG Ball Valve, Model 6675.1

The MegaPressG ball valve, model 6675.1, comes equipped with a full port silicon bronze body, a 316 stainless steel ball, and zinc-nickel-coated steel connection ends. The ball valve is PxFT and features an HNBR sealing element, a 420 SST grip ring, a 304 separator ring, and Viega's Smart Connect technology for easy identification of unpressed connections during pressure testing.

Features

- 316 stainless steel ball
- Lockable metal handle
- Double stem seal
- Reinforced PTFE seats
- Smart Connect technology

Ratings

- Temperature Range: -40°F to 180°F
- Max. Operating Pressure: 125 psi for fuel gas applications, 250 psi for other approved applications (see Viega's [Application Chart](#))

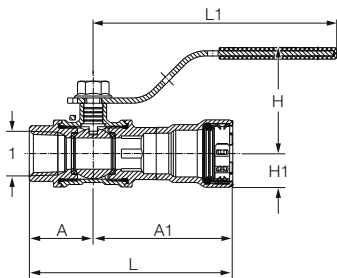

Approvals

- Conforms to MSS SP-110
- ANSI LC 4/CSA 6.32
- ANSI LC 4a/CSA 6.32a
- ASME B31

Recommended Tools

- Standard-size press tool (minimum hydraulic ram output of 7,200 lbs.)
- #56013 MegaPress jaw/ring kit

Component	Material
Body	Bronze C87700
Ball	316 Stainless Steel
Seat	Reinforced PTFE
Stem Seals	FKM or HNBR
Nut	Zinc-Plated Steel
Handle	Zinc-Plated Steel
Handle Cover	Polyvinyl
Sealing Element	HNBR
Connection Ends	Zinc-Nickel-Coated Steel
Grip Ring	420 Stainless Steel
Separator Ring	304 Stainless Steel

Part No.	Size (in)	A (in)	A1 (in)	L (in)	L1 (in)	H (in)	H1 (in)
	1						
30630	½	1.20	2.62	3.82	4.57	1.99	0.63
30635	¾	1.36	2.80	4.15	4.57	2.10	0.77
30640	1	1.85	3.16	5.00	5.77	2.46	0.91
30645	1¼	1.87	3.78	5.64	5.77	2.69	1.14
30650	1½	2.05	3.98	6.03	6.12	3.02	1.36
30655	2	2.43	4.35	6.78	6.12	3.31	1.65

Viega MegaPressG Ball Valve, Model 6675.2

The MegaPressG ball valve, model 6675.2, comes equipped with a full port silicon bronze body, a 316 stainless steel ball, and zinc-nickel-coated steel connection ends. The ball valve is P×MPT and features an HNBR sealing element, a 420 SST grip ring, a 304 separator ring, and Viega's Smart Connect technology for easy identification of unpressed connections during pressure testing.

Features

- 316 stainless steel ball
- Lockable metal handle
- Double stem seal
- Reinforced PTFE seats
- Smart Connect technology

Ratings

- Temperature Range: -40°F to 180°F
- Max. Operating Pressure: 125 psi for fuel gas applications, 250 psi for other approved applications (see Viega's [Application Chart](#))

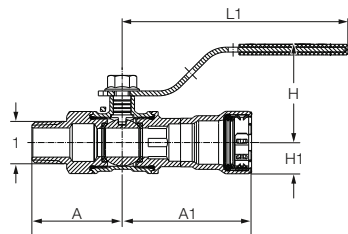

Approvals

- Conforms to MSS SP-110
- ANSI LC 4/CSA 6.32
- ANSI LC 4a/CSA 6.32a
- ASME B31

Recommended Tools

- Standard-size press tool (minimum hydraulic ram output of 7,200 lbs.)
- #56013 MegaPress jaw/ring kit

Component	Material
Body	Bronze C87700
Ball	316 Stainless Steel
Seat	Reinforced PTFE
Stem Seals	FKM or HNBR
Nut	Zinc-Plated Steel
Handle	Zinc-Plated Steel
Handle Cover	Polyvinyl
Sealing Element	HNBR
Connection Ends	Zinc-Nickel-Coated Steel
Grip Ring	420 Stainless Steel
Separator Ring	304 Stainless Steel

Part No.	Size (in)	A (in)	A1 (in)	L (in)	L1 (in)	H (in)	H1 (in)
	1						
30630	½	1.81	2.62	4.44	4.57	0.63	1.99
30635	¾	1.87	2.80	4.64	4.57	0.77	2.10
30640	1	2.53	3.16	5.69	5.77	0.91	2.46
30645	1¼	2.56	3.78	6.33	5.77	1.14	2.69
30650	1½	2.67	3.98	6.65	6.12	1.36	3.02
30655	2	2.92	4.35	7.28	6.12	1.65	3.31

Viega MegaPressG Ball Valve, Model 6675.3

The MegaPressG ball valve, model 6675.3, comes equipped with a full port silicon bronze body, a 316 stainless steel ball, and zinc-nickel-coated steel press ends. The ball valve is PxGJ and features an HNBR sealing element, a 420 SST grip ring, a 304 separator ring, and Viega's Smart Connect technology for easy identification of unpressed connections during pressure testing.

Features

- 316 stainless steel ball
- Lockable metal handle
- Double stem seal
- Reinforced PTFE seats
- Smart Connect technology

Ratings

- Temperature Range: -40°F to 180°F
- Max. Operating Pressure: 125 psi for fuel gas applications, 250 psi for other approved applications (see Viega's [Application Chart](#))

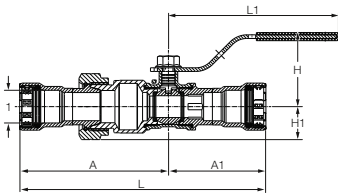

Approvals

- Conforms to MSS SP-110
- ANSI LC 4/CSA 6.32
- ANSI LC 4a/CSA 6.32a
- ASME B31

Recommended Tools

- Standard-size press tool (minimum hydraulic ram output of 7,200 lbs.)
- #56013 MegaPress jaw/ring kit

Component	Material
Body	Bronze C87700
Ball	316 Stainless Steel
Seat	Reinforced PTFE
Stem Seals	FKM or HNBR
Nut	Zinc-Plated Steel
Handle	Zinc-Plated Steel
Handle Cover	Polyvinyl
Sealing Element	HNBR
Connection Ends	Zinc-Nickel-Coated Steel
Grip Ring	420 Stainless Steel
Separator Ring	304 Stainless Steel

Part No.	Size (in)	A (in)	A1 (in)	L (in)	L1 (in)	H (in)	H1 (in)
	1						
30690	1/2	4.00	2.62	6.62	4.57	1.99	0.89
30695	3/4	4.19	2.80	6.99	4.57	2.10	1.08
30700	1	4.53	3.16	7.69	5.77	2.46	1.18
30705	1 1/4	5.65	3.78	9.43	5.77	2.69	1.50
30710	1 1/2	5.59	3.98	9.57	6.12	3.02	1.50
30715	2	6.53	4.35	10.88	6.12	3.31	1.65



A series of horizontal lines for taking notes, spanning the width of the page.

Viega MegaPress 1/2" to 2" Fittings

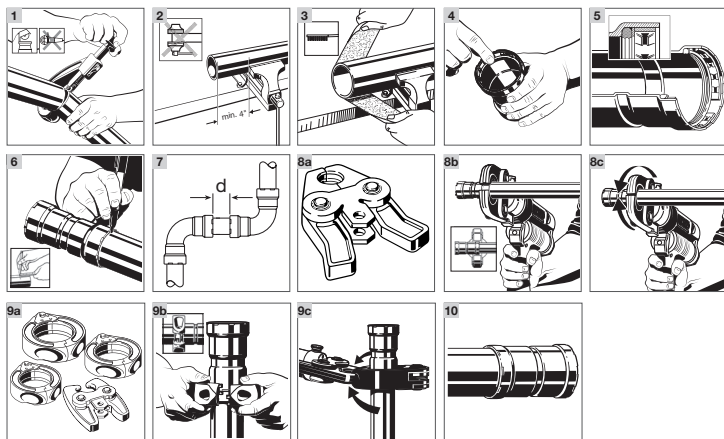

- 1** Cut piping at right angles using displacement-type cutter.
- 2** Keep end of piping a minimum of 4" away from the contact area of the vise to prevent possible damage to the piping.
- 3** Deburr inside and outside of the pipe and prep to proper insertion depth using a preparation tool or fine-grit sandpaper.
- 4** Check seal, separator ring, and grip ring for correct fit. Do not use oils or lubricants.
- 5** Illustration demonstrates proper fit of grip ring, separator ring, and sealing element.
- 6** Mark proper insertion depth. Improper insertion depth may result in an improper seal. It is recommended that the depth marking be visible on the completed assembly.

Minimum Insertion Depth for MegaPress

Pipe Size	1/2"	3/4"	1"	1 1/4"	1 1/2"	2"
Insertion Depth	1 1/16"	1 3/16"	1 3/8"	1 13/16"	1 7/8"	2"

- 7** Refer to chart on page 22 for minimum distance between fittings. Failure to provide this distance may result in an improper seal. While turning slightly, slide fitting onto pipe to the marked depth. End of pipe must contact stop.

- 8a** Viega MegaPress 1/2" to 1" fitting connections must be performed with MegaPress jaws.



WARNING!

Keep extremities and foreign objects away from press tool during pressing operation to prevent injury or incomplete press.

- 8b** Open the MegaPress jaw and place at right angles on the fitting. Visually check insertion depth using mark on piping.
- 8c** Start pressing process and hold the trigger until the jaw has engaged the fitting.
- 9a** MegaPress 1 1/4" to 2" fitting connections must be performed with MegaPress rings and V2 actuator.
- 9b** Open MegaPress ring and place at right angles on the fitting. MegaPress ring must be engaged on the fitting bead. Check insertion depth.
- 9c** Place V2 actuator onto MegaPress ring and start pressing process. Hold the trigger until the actuator has engaged the MegaPress ring.
- 10** Remove MegaPress jaw from fitting or release V2 actuator from MegaPress ring and then remove MegaPress ring from the fitting. Remove control label to indicate press has been completed.

Viega MegaPress 2½" to 4" Fittings

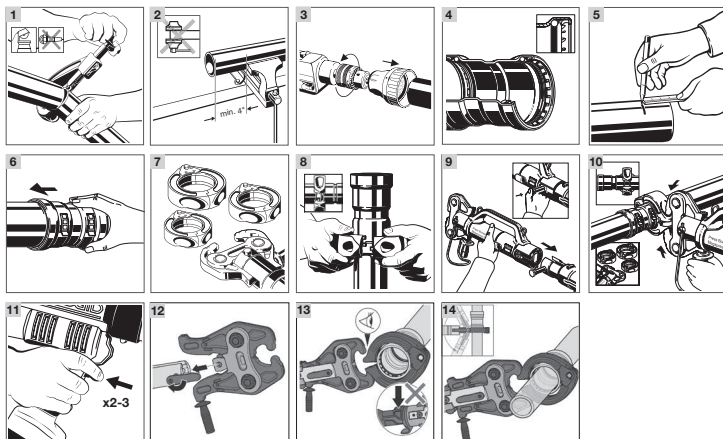

- 1 Cut piping at right angles using displacement-type cutter.
- 2 Keep end of piping a minimum of 4" away from the contact area of the vise to prevent possible damage to the piping in the press area.
- 3 Remove burr from inside and outside of piping and prep to proper insertion depth using a preparation tool or fine-grit sandpaper.
- 4 Check seal, separator ring, and grip ring for correct fit. Do not use oils or lubricants. Illustration demonstrates proper fit.
- 5 Mark proper insertion depth. Improper insertion depth may result in an improper seal. It is recommended that the depth marking be visible on the completed assembly.

**Minimum Insertion Depth for
MegaPress 2½" to 4"**

Pipe Size	2½"	3"	4"
Insertion Depth	1 ¹³ / ₁₆ "	2 ⁵ / ₁₆ "	3 ¹ / ₈ "

- 6 While turning slightly, slide fitting onto pipe to the marked depth. End of pipe must contact stop.

Caution!
Due to the brittle nature of the graphite separator ring in MegaPress G fittings, extra care must be taken when sliding the fitting onto the pipe so as not to damage the separator ring.

- 7 Viega MegaPress 2½" to 4" fitting connections must be made using MegaPress XL rings and either the MegaPress XL PressBooster or the MegaPress Z3 actuator.

WARNING!
Keep extremities and foreign objects away from press tool during pressing operation to prevent injury or incomplete press.

- 8 Open MegaPress ring and place at right angles on the fitting. The MegaPress XL ring must be engaged on the fitting bead. Check insertion depth.

Pressing with MegaPress XL PressBooster

- 9** Remove the retaining bolt of the press machine. Slide the PressBooster in via the press jaw fixture. Slide the retaining bolt of the press machine in as far as it will go.
- 10** To open the PressBooster jaw, pull back the handle at the hinged adapter jaw. Place PressBooster onto the MegaPress XL ring by inserting the ball heads of the hinged adapter jaw into the contact points of the XL ring. Push the handle forward to close the hinged adapter jaw.
- 11** Hold the trigger until the actuator has engaged the MegaPress XL ring. The PressBooster requires two presses of the trigger to execute a complete press. A third press may be needed to initiate a release cycle to reset the rollers back to the original position.

Pressing with MegaPress Z3 Actuator

- 12** On the press tool, rotate the retaining pin handle 180 degrees and pull it out to open the slot for the actuator. Insert the Viega Z3 actuator into the slot on the press tool. On the press tool, push the retaining pin back in and rotate it 180 degrees.
- 13** Open the Viega Z3 actuator by pulling the handle back. Place the open Viega Z3 actuator onto the MegaPress XL ring by inserting the ball heads of the actuator into the contact points of the XL ring. Close the Z3 actuator.
- 14** Start the pressing process by holding the press tool trigger until the actuator has engaged the XL ring. When the press cycle is complete, the actuator will stop and release.

Approved Applications

Media ¹	System Operating Conditions			Product Line, Material, and Sealing Element ²		
				MegaPress	MegaPressG	
	Comments	Max Pressure (psig)	Temperature Range (°F)	EPDM	FKM	HNBR
Water/Liquids						
Chilled Water	≤50% Ethylene / Propylene glycol	200	See note ³	✓	✓	
Hydronic Heating Water ⁹	≤50% Ethylene / Propylene glycol			✓	✓	
Isopropyl alcohol			Ambient ⁵	✓	✓	
Fire Sprinkler	NFPA 13, 13D, 13R	175		✓	✓	
Steam	Low pressure	15	Max 250°		✓ ⁴	
	Residential	5	Max 227°	✓ ⁴	✓ ⁴	
Gases						
Compressed Air	Oil Concentration ≤25 mg/m ³	200	Max 140°	✓ ⁴	✓ ⁴	✓ ⁴
	Oil Concentration >25 mg/m ³				✓ ⁴	✓ ⁴
Nitrogen - N ₂				✓	✓	✓
Carbon Dioxide - CO ₂ Dry				✓	✓	✓
Argon - Ar				✓	✓	✓
Ammonia	Ammonia environment ⁷			Max 120°	✓	✓
Oxygen - O ₂	Non-medical Keep free of oil and grease	140	Max 140°	✓		
Hydrogen - H ₂		125		✓	✓	✓
Acetylene	Test pressure 350 psi	20	Ambient ⁵	✓	✓	✓
Vacuum	Minimum absolute pressure Maximum differential pressure	750µm Hg 29.2" Hg	Max 160°	✓	✓	✓

¹ It is recommended that all systems be clearly labeled with the media being conveyed. For further information please consult Viega Technical Support.

² All Viega systems must be used with the manufacturer's recommended sealing element. Contact your local Viega representative or Viega Technical Support for specific application temperature, pressure, and concentration limits.

³ System pressure and temperature ranges depend on sealing element. Any ranges listed above will be overruled by the sealing element limits here:

^{3a} EPDM temperature ranges are typically 0°F to 250°F.

^{3b} FKM temperature ranges are typically 14°F to 284°F with temperature spikes (24hr) up to 356°F.

^{3c} HNBR temperature ranges are typically -40°F to 180°F.

⁴ System must contain adequate condensate drainage.

⁵ Ambient temperatures should be taken as normal operating conditions for the applications not to exceed sealing element limitations.

⁶ Compliant with CSA 6.32 / ANSI LC-4.

⁷ All copper or copper alloy components that are exposed in ammonia environments require lacquer or paint coating.

⁸ HNBR sealing elements are not recommended for silicone based oils.

⁹ It is a Viega engineering best practice that for heating applications using EPDM, where the media will be running continuously, non-stop at 200°F or above, to consider switching to an FKM sealing element.

¹⁰ MegaPressG fittings with HNBR sealing elements are compliant with standard UL 180 for combustible liquid applications.

¹¹ Not approved for use in Canada.



Caution!

MegaPressG fittings are for use with fuel gases and are intended for the operating pressure 0-125 psi.

Media ¹	System Operating Conditions			Product Line, Material, and Sealing Element ²		
				MegaPress	MegaPressG	
	Comments	Max Pressure (psig)	Temperature Range (°F)	Carbon Steel		
EPDM				FKM	HNBR	
Fuels/Oils/Lubricants						
Mineral Oil		200	Ambient ⁵		✓	✓
Lube Oil ¹¹	Petroleum based		Max 150°		✓	✓
Biodiesel ¹¹	ASTM D6751	140			✓	
Propane						✓ ⁶
Butane			-40° to 180			✓ ⁶
Natural Gas	Primarily methane					✓ ⁶
Heating Fuel Oil ¹¹			Max 100°		✓	✓ ¹⁰
Diesel Fuel ¹¹			Max 68°		✓	✓ ¹⁰
Kerosene ¹¹					✓	
Gear Oil	Lubricant	125			✓	✓
Automatic Transmission Fluid					✓	✓
Hydraulic Oil			See note ³		✓	✓ ⁸
Engine Oil					✓	✓ ^{8, 10}
Engine Coolant				✓	✓	
Waste Oil					✓	✓ ^{8, 10}

¹ It is recommended that all systems be clearly labeled with the media being conveyed. For further information please consult Viega Technical Support.

² All Viega systems must be used with the manufacturer's recommended sealing element. Contact your local Viega representative or Viega Technical Support for specific application temperature, pressure, and concentration limits.

³ System pressure and temperature ranges depend on sealing element. Any ranges listed above will be overruled by the sealing element limits here:

^{3a} EPDM temperature ranges are typically 0°F to 250°F.

^{3b} FKM temperature ranges are typically 14°F to 284°F with temperature spikes (24hr) up to 356°F.

^{3c} HNBR temperature ranges are typically -40°F to 180°F.

⁴ System must contain adequate condensate drainage.

⁵ Ambient temperatures should be taken as normal operating conditions for the applications not to exceed sealing element limitations.

⁶ Compliant with CSA 6.32 / ANSI LC-4.

⁷ All copper or copper alloy components that are exposed in ammonia environments require lacquer or paint coating.

⁸ HNBR sealing elements are not recommended for silicone based oils.

⁹ It is a Viega engineering best practice that for heating applications using EPDM, where the media will be running continuously, non-stop at 200°F or above, to consider switching to an FKM sealing element.

¹⁰ MegaPressG fittings with HNBR sealing elements are compliant with standard UL 180 for combustible liquid applications.

¹¹ Not approved for use in Canada.



Caution!

MegaPressG fuel gas system shall not be used as a grounding electrode for an electrical system.



The installation, inspection, testing, and purging of the fuel gas system shall be in accordance with local codes or, in the absence of local codes, in accordance with the International Fuel Gas Code, NFPA 54/National Fuel Gas Code z223.1, the Uniform Plumbing Code, NFPA 58, or CSA B 149.1 as applicable.



The use of the system for applications other than those listed or outside of these parameters must be approved by the Viega Technical Support (techsupport@viega.us).

Sealing Element Description

EPDM Sealing Element

MegaPress press fittings are manufactured with an EPDM sealing element installed at the factory. The EPDM sealing element is used mainly for hydronic heating, fire sprinkler, and compressed-air installations.

Definition: EPDM
Ethylene-Propylene-Diene-Monomer, gloss black in color

Operating Temperature: 0°F to 250°F

The EPDM sealing element is a synthetically manufactured and peroxidically cross-linked, general-purpose elastomer with a wide range of applications. It is resistant to aging, ozone, sunlight, weathering, environmental influences, chemicals, and most alkaline solutions.

The EPDM sealing element is used mainly in the applications of hydronic heating, chilled water, and fire sprinkler installations. It is not resistant to hydrocarbon solvent solutions, oils, chlorinated hydrocarbons, turpentine, or gasoline.

FKM Sealing Element

MegaPress FKM press fittings are manufactured with an FKM sealing element installed at the factory. FKM is well known for its excellent resistance to petroleum products and solvents as well as for its exceptional high-temperature performance, which makes it ideal for seals and gaskets in solar, district heating, low-pressure steam, and compressed-air systems.

Definition: FKM
Fluoroelastomer, dull black in color

Operating Temperature: 14°F to 284°F
(with temperature spikes up to 356°F)

The FKM sealing element is a special-purpose elastomer typically installed where higher temperatures are required. It possesses excellent resistance to aging, ozone, sunlight, weathering, environmental influences, and oils and petroleum-based additives.

HNBR Sealing Element

MegaPressG press fittings are manufactured with an HNBR sealing element installed at the factory. The HNBR sealing element is used mainly for natural gas, propane, and mixed and manufactured gases in the vapor state. It is commonly used in fuel oil heating systems.

Definition: HNBR
Hydrogenated Nitrile Butadiene Rubber, yellow in color

Operating Temperature: -40°F to 180°F

HNBR is widely known for its physical strength and retention of its properties after long-term exposure to heat, oil, and chemicals.

The unique properties of the HNBR sealing element have resulted in its wide adoption for automotive, industrial, and assorted performance-demanding applications (e.g., engine seals, grommets, and gaskets; fuel system seals and hoses; transmission system bonded piston seals; chevron seals, oil field packers, and rotary shaft seals).

The HNBR sealing element is not suitable for food contact applications and cannot be installed in drinking water applications.

Viega MegaPress Pipe Marking Guide

Viega MegaPress ½" to 4" fittings are compatible with ASTM A53, A135, A106, and A795 carbon steel and galvanized steel pipe. All Viega MegaPress piping systems should be continuously marked in accordance with ANSI A13.1 or as required by the local authority having jurisdiction.

Usage	Material Properties	Type of Application (typical)	Color Scheme
Hazardous Materials	<ul style="list-style-type: none"> ■ Flammable or Explosive ■ Chemically Active or Toxic ■ Radioactive ■ Extreme Temperature/Pressure 	<ul style="list-style-type: none"> ■ Process Piping ■ High-Pressure Steam ■ Acids/Corrosives 	YELLOW ON BLACK
Low Hazard Materials (Liquid)	<ul style="list-style-type: none"> ■ Liquid ■ Liquid Admixture 	<ul style="list-style-type: none"> ■ Cooling Water ■ Grey Water ■ Chilled Water 	WHITE ON GREEN
Low Hazard Materials (Gas)	<ul style="list-style-type: none"> ■ Gas ■ Gas Admixture 	<ul style="list-style-type: none"> ■ Compression Air ■ Nitrogen (N₂) ■ Argon (Ar) 	WHITE ON BLUE
Fire Suppression	<ul style="list-style-type: none"> ■ Liquid ■ Gas ■ Foam 	<ul style="list-style-type: none"> ■ Sprinklers (Wet/Dry) ■ CO₂ ■ Foam (AFFF) 	WHITE ON RED

Marker Placement

- At all changes in direction
- At both sides of any penetrations (valves, flanges, tees, etc.)
- At frequent intervals on straight run (50 feet is typical)
- Locate pipe markers so they are readily visible
- Provide arrows indicating direction of flow

Pipe O.D. Including Covering		Minimum Length of Label Field Color		Minimum Height of Letters	
(in)	(mm)	(in)	(mm)	(in)	(mm)
¾ to 1¼	19 to 32	8	203	½	13
1½ to 2	38 to 51	8	203	¾	19
2½ to 4	64 to 102	12	305	1¼	32



This guide is for general information purposes only. Pipe markings shall be in accordance with local code requirements.

No-Stop Couplings

No-stop couplings and extended no-stop couplings are often used to conduct repairs. Without a stop, these couplings can slide completely onto a pipe and allow a connection to be made in tighter spaces. Unlike fittings with an integrated stop that have a minimum insertion depth, no-stop couplings have minimum and maximum allowable insertion depths. The minimum and the maximum insertion depths should be marked and a line should connect the two marks.

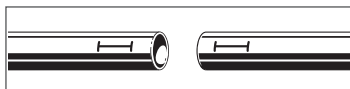

Viega MegaPress No-Stop Couplings

Pipe Diameter (in)	Minimum Insertion (in)	Minimum Insertion (mm)	Maximum Insertion (in)	Maximum Insertion (mm)
1/2	1 1/16	27	1 5/8	41
3/4	1 3/16	30	1 13/16	46
1	1 3/8	35	1 15/16	49
1 1/4	1 13/16	46	2 1/2	64
1 1/2	1 7/8	48	2 3/4	70
2	2	51	2 3/4	70
2 1/2	1 13/16	46	3 1/8	79
3	2 5/16	59	3 11/16	94
4	3 1/8	80	4 3/8	111

**Viega MegaPress
Extended No-Stop Couplings**

Pipe Diameter (in)	Minimum Insertion (in)	Minimum Insertion (mm)	Maximum Insertion (in)	Maximum Insertion (mm)
1/2	1 1/16	27	2 3/4	70
3/4	1 3/16	30	2	71
1	1 3/8	35	3	76
1 1/4	1 13/16	46	3 1/2	89
1 1/2	1 7/8	48	3	90
2	2	51	3	94

Welding

The following requirements must be considered when welding in the same vicinity as Viega MegaPress fittings.

Welding Requirements

The installer should take precautions to keep the MegaPress connection cool:

- Wrap the connection with a cold wet rag.
- Protect the connection with a weld blanket.
- Prefabricate solder connections/welded fittings prior to installing the press fitting. (Ensure pipe has cooled before installing the press fitting.)
- Apply heat sink gel or spray or spot freezing.

Welding Adjacent to a Press Fitting

To prevent damage to the sealing element, maintain proper welding distances from the fitting. If welding adjacent to the connection, weld a minimum of four inches away.

Welding in Line With a Press Fitting

To prevent damage to the sealing element, maintain proper welding distances from the fitting. If welding in line with the connection, weld a minimum of three feet away from the connection.

Minimum Distance Between MegaPress Connections

Viega MegaPress Minimum Distance

Pipe Diameter (in)	Minimum Distance (in)	Minimum Distance (mm)
1/2	1/4	7
3/4	1/4	7
1	1/4	7
1 1/4	1/2	13
1 1/2	1/2	13
2	1/2	13
2 1/2	1/2	13
3	1/2	13
4	1/2	13

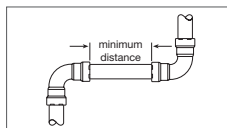

General Installation Notes

Expansion

Thermal expansion in installed systems generates stress on pipes and appliance connectors. Compensation must be allowed for expansion and contraction that may occur within the piping system. Expansion joints or mechanical expansion compensators may be used to alleviate these stresses.

Electrical Bonding

When properly installed, MegaPress fittings comply with Section 1211.15 Electrical Bonding and Grounding of the Uniform Plumbing Code.

The mechanical press provides continuous metal-to-metal contact between fitting and pipe. The press ensures the continuity of the bonding through this contact.



Caution!
Potential Explosive Hazard – MegaPressG

The fuel gas system shall not be used as a grounding electrode for an electrical system.



DANGER!
Electric Shock

An electric shock can cause burns, serious injury, and even death.

- Because all metallic piping can conduct electricity, unintentional contact with a live wire can cause the entire system and components connected to it to become energized. Metal piping is not meant to conduct electricity.
- A properly bonded system creates a safe path for electricity to travel so that the system can't be energized.
- An unbonded or improperly bonded system can be a shock hazard.
- Always ensure that bonding is in accordance with local codes.

Exposure to Freezing Temperatures

Viega MegaPress systems with EPDM sealing elements can be installed in ambient temperatures down to 0°F. The FKM sealing element available with Viega MegaPress FKM fittings can be installed in ambient temperatures down to 14°F. The HNBR sealing element available with Viega MegaPressG fittings can be installed in ambient temperatures down to -40°F. When the contents could freeze, piping must be protected per acceptable engineering practices, codes, and as required by local code.

Underground Installations

Viega MegaPress fitting systems and carbon steel pipe are approved for underground installations. However, installations must meet all state and local codes, including those for underground. Proper authorization must be obtained from the Authority Having Jurisdiction prior to installation.

Concealed Spaces

The Viega MegaPress fitting system has been approved for use in concealed spaces. Viega MegaPressG has been examined according to the construction and performance criteria in the ANSI LC-4/CSA 6.32 requirement and was found acceptable. Specific performance tests were conducted to evaluate the fittings for use in concealed locations.

Corrosion Protection

Viega MegaPress fittings exposed to corrosive action, such as soil conditions or moisture, must be protected in an approved manner in accordance with NFPA 54 Section 404.8, NACE Standard RP0169-2002 Section 5, 2009 UPC Chapter 6 Section 609.3.1, 2009 UMC Chapter 13 Section 1312.1.3, and in a manner satisfactory to local code requirements. Care should be taken to select hangers of suitable material that is galvanically compatible with the piping system. In addition, systems should be properly sized to minimize the risk of erosion corrosion resulting from excessive velocities.

Pressure Surges

- Pressure surges or transients from fast-acting valves, pump surges, and other sources that result in water hammer may cause damage to many system components, including press fittings.
- When fast-acting valves and/or pumps are incorporated into a system, the designer and installer should isolate press fittings from sharp pressure surges.

Transition Fittings – Threaded

Viega MegaPress systems can be joined with off-the-shelf threaded fittings made of non-ferrous metals. In this regard:

- The threaded connection is made first.
- The press connection is made second. This process avoids unnecessary torsion on the press fitting.

Transition Fittings – Flange

When using Viega flanges, bolt the flange end in place prior to pressing the fitting to the pipe.

Deflection

The pressing process can cause deflection (angular misalignment) to occur. When pressing Viega MegaPress fittings in a system, the deformation of the fitting is constant. This allows for a consistent leak-free joint every time and is a result of the pressing technique.

Deflection occurs in the same way for every fitting. The fitting being pressed will move in the direction of the jaw or ring opening.

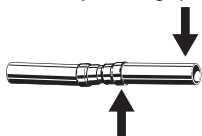

- Since the fitting will deflect toward the opening of the jaw or ring, the pipe end will deflect in the opposite direction.
- By counteracting the fitting movement, one can minimize the deflection of the fitting and ultimately the pipe.

- When using strut and clamps, deflection is minimized and nearly eliminated, depending on clamp spacing.

Controlling Deflection

Deflection while pressing can be minimized by utilizing the following installation practices.

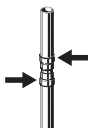

Alternate Press Directions

- Press one end of fitting.
- Make second press on other end of fitting from the opposite side.

Push-Pull Method

- Rings = Push on press tool.
 - Jaws = Pull on press tool.
- The press tool can be feathered using the trigger as needed to apply pulling or pushing force to control deflection.

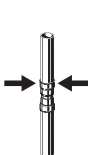
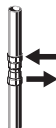





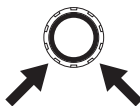





Re-Press

- Press the fitting, once on each side (that is, re-press the fitting a second time on the opposite side).
- Pressing the same connection from the opposite side will usually straighten misalignment between the pipe and fitting.

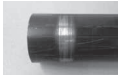

- When pressing overhead piping, it may be inconvenient to alternate sides for each press.
- The natural weight of the piping plus pressing on opposite sides at a 45-degree angle should adequately eliminate deflection.
- This technique can also be used for any horizontal piping and when working above the piping.

Viega MegaPress Pipe Preparation Guide

Description	Different kinds of pipe surface	Surface after prepping	Comments
Clean, bare pipe			If the pipe has no lacquer and there is no rust on the surface and the surface is smooth, no preparing is necessary.
Galvanized steel pipe			If the surface of the galvanized pipe is uneven, then the pipe surface must be smoothed.
Pipe with black shellac or lacquer			If the pipe is coated with black shellac or lacquer, the coating has to be smoothed. It is not necessary to completely remove the coating.
Pipe with rust			If the pipe has no lacquer and there is a rust film on the surface, the surface has to be prepped until the rust film is removed and the pipe surface is smooth.
Epoxy coating			The epoxy coating must be reduced to allow the pipe to be inserted into the fitting. If the pipe has been coated, the maximum external diameter must not exceed the limit in the Pipe Schedule table.
Cataphoretic paint (KTL)			If the pipe is cataphoretic painted (KTL) and the surface is smooth, it is not necessary to prep the pipe. If there are scratches on the KTL, the surface has to be smoothed.

Pipe surfaces for each type of pipe must be smooth, free of indentations (even and undamaged), pits, and deformations, and must be clean and free of dirt, debris, rust, scale, oil, and grease. It is not necessary to completely remove protective coatings or to expose the bare steel material.

Install MegaPress fittings on plain end pipe only. Pressing fittings directly over threads will result in an improper seal.

To avoid leak paths, engraved or stamped pipe shall not be used with the Viega MegaPress fitting system. Engraving or stamping shall not be removed through use of a grinder or other tool. Scratches or scuffs that may have occurred to the pipe during shipping and handling must be smoothed out to insure no leak path was created.

In systems where complete corrosion protection is required (e.g., cooling systems), apply suitable corrosion protection to the previously processed pipe surfaces that are still uncovered after pressing.

The Viega MegaPress system does not require lubrication of the pipe or the fitting.

Tool Clearances

Minimum distances should be taken into consideration during planning in order to avoid space constraints during installation.

Ensure that the space required for pressing tools is available if Viega MegaPress fittings will be installed immediately upstream or downstream from wall or floor penetrations.

MegaPress Distance Requirements for Press Jaws Between Pipes and Walls

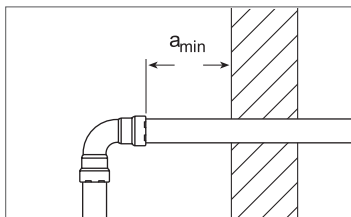

Pipe Diameter	Minimum space requirement, a_{min} for press tools
	RIDGID RP 330-B, 330-C, and 340-B Press Tools
½" to 1"	1½"
1¼" to 2"	¾"
2½" to 4"	¾"

MegaPress Standard Jaws Clearance

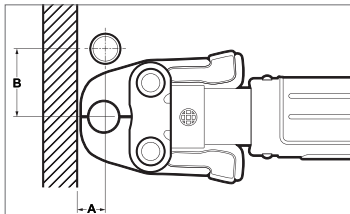

Pipe Diameter	A minimum	B minimum
½"	1	2½"
¾"	1¼"	3½"
1"	1¾"	3½"

MegaPress Compact Jaws Clearance

Pipe Diameter	A minimum	B minimum
½"	1¼"	2½"
¾"	1½"	3"

MegaPress Standard Jaws Clearance Between Pipe, Wall, and Floor

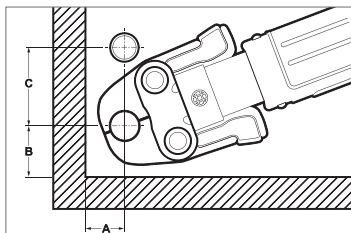

Pipe Diameter	A minimum	B minimum	C minimum
1/2"	1 1/4"	1 7/8"	3"
3/4"	1 1/2"	2 1/8"	3 1/2"
1"	2"	2 1/2"	4"

MegaPress Compact Jaws Clearance Between Pipe, Wall, and Floor

Pipe Diameter	A minimum	B minimum	C minimum
1/2"	1 1/2"	2 1/8"	3 1/8"
3/4"	1 3/8"	2 1/8"	3 3/8"

MegaPress Rings Dimensions

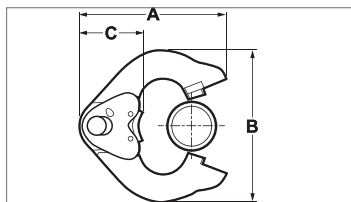

Pipe Diameter	A minimum	B minimum	C minimum
1 1/4"	6"	6 1/4"	2 1/2"
1 1/2"	6"	6 3/4"	2 5/8"
2"	6"	6 7/8"	2 1/2"
2 1/2"	6 5/8"	7 5/8"	2 1/2"
3"	7 1/2"	8 3/8"	2 1/2"
4"	8 1/2"	10 3/8"	2 5/8"

MegaPress Rings with V2/V3 Actuator Clearance

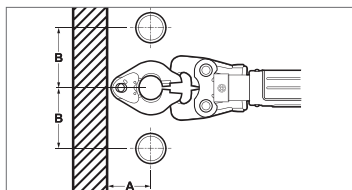

Pipe Diameter	A minimum	B minimum
1 1/4"	3 3/4"	4 7/8"
1 1/2"	4"	5 1/8"
2"	4"	5 3/8"
2 1/2"	4 1/2"	5 5/8"
3"	4 3/4"	6 3/4"
4"	5 3/8"	8 1/4"

MegaPress Rings with V2/V3 Actuator Clearance Between Pipe, Wall, and Floor

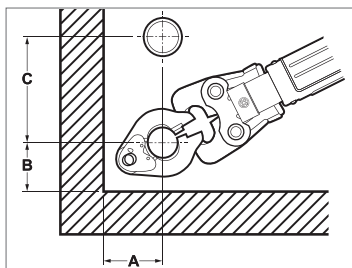

Pipe Diameter	A minimum	B minimum	C minimum
1 1/4"	3 3/4"	3 3/4"	4 7/8"
1 1/2"	4"	4"	5 1/8"
2"	4"	4"	5 3/8"
2 1/2"	4 1/2"	4"	5 5/8"
3"	4 3/4"	4 3/4"	6 3/4"
4"	5 3/8"	5 1/2"	8 1/4"

Pressing with Ring and Actuator in Tight Quarters

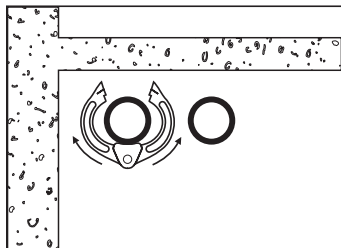

1. Wrap the actuator ring around the press fitting with the opening facing away from you.

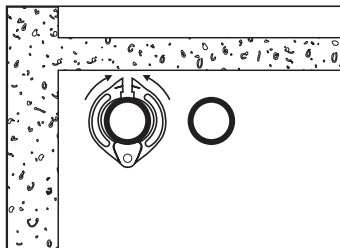

2. Close the actuator tight around the fitting.

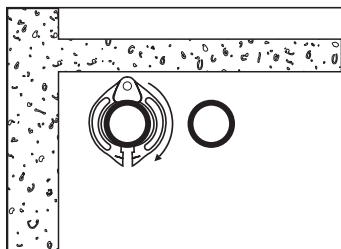

3. Rotate the actuator ring until the press jaw receptacle is facing toward you.

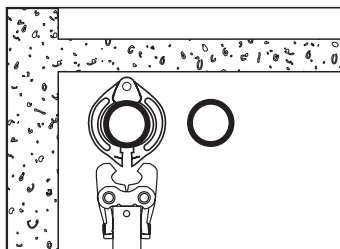

4. Properly insert press jaws and begin the press procedure.

Dimensional Documentation
MegaPress Fittings



MegaPress 90° Elbow, Carbon Steel, P x P - Models 4816 / 5916 / 6616

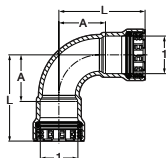

Part No.			Size (in)		A (in)		L (in)	
EPDM	FKM	HNBR	1	Dec	Frac	Dec	Frac	
25200	84305	25201	1/2	1.17	1 1/16	2.24	2 1/4	
25205	84310	25206	3/4	1.36	1 3/8	2.52	2 1/2	
25210	84315	25211	1	1.72	1 3/4	3.07	3 1/16	
25215	84320	25216	1 1/4	2.00	2	3.82	3 13/16	
25220	84325	25221	1 1/2	2.26	2 1/4	4.13	4 1/8	
25225	84330	25226	2	2.80	2 13/16	4.78	4 3/4	

Viega MegaPress 90° Elbow P x P - Models 4816XL / 6616XL

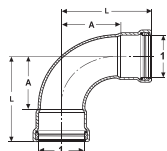

Part No.		Size (in)		A (in)		L (in)	
FKM	HNBR	1	Dec	Frac	Dec	Frac	
26500	28600	2 1/2	4.15	4 1/8	5.94	5 15/16	
26505	28605	3	4.76	4 3/4	7.09	7 1/16	
26510	28610	4	6.00	6	9.17	9 3/16	

MegaPress 90° Elbow, Carbon Steel, P x FTG - Models 4816.1 / 5916.1 / 6616.1

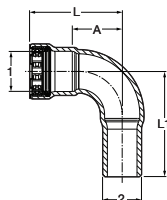

Part No.			Size (in)		A (in)		L (in)		L1 (in)	
EPDM	FKM	HNBR	1	2	Dec	Frac	Dec	Frac	Dec	Frac
26050	84875	26051	1/2 x 1/2	1.17	1 1/16	2.24	2 1/4	2.56	2 9/16	
26055	84880	26056	3/4 x 3/4	1.36	1 3/8	2.52	2 1/2	2.87	2 7/8	
26060	84885	26061	1 x 1	1.72	1 3/4	3.07	3 1/16	3.39	3 3/8	
26065	84890	26066	1 1/4 x 1 1/4	2.00	2	3.82	3 13/16	4.04	4 1/16	
26070	84895	26071	1 1/2 x 1 1/2	2.26	2 1/4	4.13	4 1/8	4.21	4 3/16	
26075	84900	26076	2 x 2	2.80	2 13/16	4.78	4 3/4	5.08	5 1/16	

Viega MegaPress 90° Street Elbow P x FTG - Models 4816.1XL / 6616.1XL

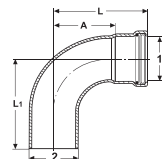

Part No.		Size (in)		A (in)		L (in)		L1 (in)	
FKM	HNBR	1	2	Dec	Frac	Dec	Frac	Dec	Frac
26515	28615	2 1/2 x 2 1/2	4.15	4 1/8	5.94	5 15/16	6.06	6 1/16	
26520	28620	3 x 3	4.76	4 3/4	7.09	7 1/16	6.81	6 13/16	
26525	28625	4 x 4	6.00	6	9.17	9 3/16	8.78	8 3/4	

MegaPress 45° Elbow, Carbon Steel, P x P - Models 4826 / 5926 / 6626

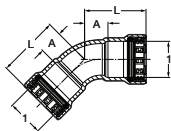

Part No.			Size (in)		A (in)		L (in)	
EPDM	FKM	HNBR	1	Dec	Frac	Dec	Frac	
25230	84335	25231	½	0.60	5/8	1.67	1 1/16	
25235	84340	25236	¾	0.71	11/16	1.87	1 7/8	
25240	84345	25241	1	0.86	7/8	2.20	2 3/16	
25245	84350	25246	1 ¼	0.98	1	2.80	2 13/16	
25250	84355	25251	1 ½	1.12	1 1/8	2.99	3	
25255	84360	25256	2	1.32	1 5/16	3.31	3 5/16	

Viega MegaPress 45° Elbow P x P - Models 4826XL / 6626XL

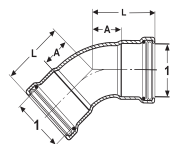

Part No.		Size (in)		A (in)		L (in)	
FKM	HNBR	1	Dec	Frac	Dec	Frac	
26530	28630	2 ½	2.10	2 1/8	3.90	3 7/8	
26535	28635	3	2.26	2 ¼	4.56	4 9/16	
26540	28640	4	2.74	2 ¾	5.92	5 15/16	

MegaPress 45° Elbow, Carbon Steel, P x FTG - Models 4826.1 / 5926.1 / 6626.1

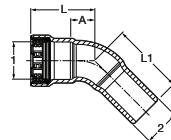

Part No.			Size (in)		A (in)		L (in)		L1 (in)	
EPDM	FKM	HNBR	1	2	Dec	Frac	Dec	Frac	Dec	Frac
26100	84905	26101	½ x ½	0.60	5/8	1.67	1 1/16	1.97	1 15/16	
26105	84910	26106	¾ x ¾	0.71	11/16	1.87	1 7/8	2.13	2 1/8	
26110	84915	26111	1 x 1	0.86	7/8	2.20	2 3/16	2.52	2 ½	
26115	84920	26116	1 ¼ x 1 ¼	0.98	1	2.80	2 13/16	2.99	3	
26120	84925	26121	1 ½ x 1 ½	1.12	1 1/8	2.99	3	3.07	3 1/16	
26125	84930	26126	2 x 2	1.32	1 5/16	3.31	3 5/16	3.58	3 9/16	

Viega MegaPress 45° Street Elbow P x FTG - Models 4826.1XL / 6626.1XL

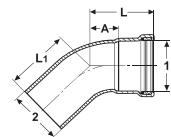

Part No.		Size (in)		A (in)		L (in)		L1 (in)	
FKM	HNBR	1	2	Dec	Frac	Dec	Frac	Dec	Frac
26545	28645	2 ½ x 2 ½	2.10	2 1/8	3.90	3 7/8	3.95	3 15/16	
26550	28650	3 x 3	2.26	2 ¼	4.56	4 9/16	4.34	4 5/16	
26555	28655	4 x 4	2.74	2 ¾	5.92	5 15/16	5.62	5 5/8	

MegaPress Tee, Carbon Steel, P x P x P - Models 4818 / 5918 / 6618

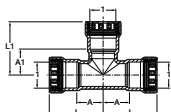

Part No.			Size (in)			A (in)		A1 (in)		L (in)		L1 (in)	
EPDM	FKM	HNBR	1	Dec	Frac	Dec	Frac	Dec	Frac	Dec	Frac	Dec	Frac
25300	84365	25301	½	0.97	1	0.93	15/16	2.04	2 1/16	2.00	2		
25305	84370	25306	¾	1.11	1 1/8	1.09	1 1/16	2.26	2 ¼	2.24	2 ¼		
25310	84375	25311	1	1.23	1 ¼	1.23	1 ¼	2.57	2 9/16	2.57	2 9/16		
25315	84395	25316	1 ¼	1.41	1 7/16	1.38	1 3/8	3.23	3 ¼	3.20	3 3/16		
25320	84400	25321	1 ½	1.57	1 9/16	1.54	1 9/16	3.44	3 7/16	3.41	3 7/16		
25325	84405	25326	2	1.81	1 13/16	1.80	1 13/16	3.80	3 13/16	3.79	3 13/16		

Viega MegaPress Tee P x P x P - Models 4818XL / 6618XL

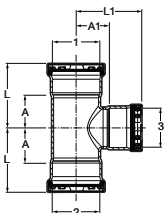

Part No.		Size (in)			A (in)		A1 (in)		L (in)		L1 (in)	
FKM	HNBR	1	2	3	Dec	Frac	Dec	Frac	Dec	Frac	Dec	Frac
NA	28910	2 ½	x 2 ½	x 1	1.35	1 3/8	2.04	2 1/16	3.15	3 1/8	3.38	3 3/8
NA	28905	2 ½	x 2 ½	x 1 ¼	1.72	1 ¾	2.06	2 1/16	3.52	3 ½	3.87	3 7/8
26575	28675	2 ½	x 2 ½	x 1 ½	1.72	1 ¾	2.08	2 1/16	3.52	3 ½	3.95	3 15/16
26580	28680	2 ½	x 2 ½	x 2	2.16	2 9/16	2.05	2 1/16	3.96	3 5/16	4.04	4 1/16
26560	28660	2 ½	x 2 ½	x 2 ½	2.16	2 3/16	2.26	2 ¼	3.96	3 5/16	4.06	4 1/16
26595	28695	3	x 3	x 1 ¼	1.70	1 1/16	2.31	2 5/16	4.04	4 1/16	4.13	4 1/8
26590	28690	3	x 3	x 1 ½	1.80	1 13/16	2.33	2 5/16	4.13	4 1/8	4.20	4 3/16
26585	28685	3	x 3	x 2	2.11	2 1/8	2.30	2 5/16	4.41	4 7/16	4.29	4 5/16
26600	28700	3	x 3	x 2 ½	2.32	2 7/16	2.51	2 ½	4.63	4 5/8	4.31	4 5/16
26565	28665	3	x 3	x 3	2.55	2 9/16	2.52	2 ½	4.88	4 7/8	4.82	4 13/16
26605	28705	4	x 4	x 1 ½	1.86	1 7/8	2.90	2 7/8	5.04	5 1/16	4.77	4 3/4
26610	28710	4	x 4	x 2	2.18	2 3/16	2.87	2 7/8	5.35	5 3/8	4.86	4 7/8
26615	28715	4	x 4	x 2 ½	2.40	2 3/8	3.08	3 1/16	5.55	5 9/16	4.88	4 7/8
26620	28720	4	x 4	x 3	2.66	2 11/16	3.13	3 1/8	5.81	5 ¾	5.43	5 1/16
26570	28670	4	x 4	x 4	3.22	3 ¼	3.08	3 1/16	6.40	6 3/8	6.26	6 ¼

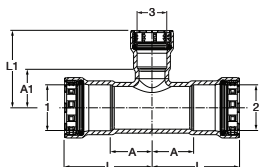
MegaPress Reducing Tee, Carbon Steel, P x P x P - Models 4818 / 5918 / 6618

Part No.			Size (in)			A (in)		A1 (in)		L (in)			L1 (in)		
EPDM	FKM	HNBR	1	2	3	Dec	Frac	Dec	Frac	Dec	Frac	Dec	Frac	Dec	Frac
25330	84410	25331	3/4	x 3/4	x 1/2	1.11	1/8	1.07	1/16	2.26	2/4	2.14	2/8		
25335	84415	25336	1	x 1	x 1/2	1.23	1/4	1.20	3/16	2.57	2/16	2.28	2/4		
25340	84420	25341	1	x 1	x 3/4	1.23	1/4	1.24	1/4	2.57	2/16	2.40	2/8		
25510	84380	25491	1 1/4	x 1 1/4	x 1/2	1.41	1/16	1.35	1/8	3.23	3/4	2.42	2/16		
25515	84385	25496	1 1/4	x 1 1/4	x 3/4	1.41	1/16	1.39	1/8	3.23	3/4	2.55	2/16		
25350	84390	25351	1 1/4	x 1 1/4	x 1	1.41	1/16	1.38	1/8	3.23	3/4	2.73	2/8		
25360	84425	25361	1 1/2	x 1 1/2	x 1/2	1.57	1/16	1.44	1/16	3.44	3/16	2.51	2/12		
25365	84430	25366	1 1/2	x 1 1/2	x 3/4	1.57	1/16	1.48	1/2	3.44	3/16	2.64	2/5		
25370	84435	25371	1 1/2	x 1 1/2	x 1	1.57	1/16	1.48	1/2	3.44	3/16	2.83	2/13		
25375	84440	25376	1 1/2	x 1 1/2	x 1 1/4	1.57	1/16	1.50	1/2	3.44	3/16	3.32	3/5		
25380	84445	25381	2	x 2	x 1/2	1.81	1/16	1.74	1/4	3.80	3/16	2.81	2/13		
25385	84450	25386	2	x 2	x 3/4	1.81	1/16	1.80	1/16	3.80	3/16	2.95	2/15		
25390	84455	25391	2	x 2	x 1	1.81	1/16	1.75	1/4	3.80	3/16	3.10	3/8		
25395	84460	25396	2	x 2	x 1 1/4	1.81	1/16	1.78	1/4	3.80	3/16	3.60	3/5		
25400	84465	25401	2	x 2	x 1 1/2	1.81	1/16	1.84	1/16	3.80	3/16	3.71	3/1/16		

MegaPress Reducing Tee, Carbon Steel, P x P x FPT - Models 4817.2 / 5917.2 / 6617.2

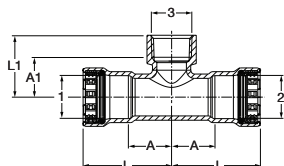

Part No.			Size (in)			A (in)		A1 (in)		L (in)		L1 (in)	
EPDM	FKM	HNBR	1	2	3	Dec	Frac	Dec	Frac	Dec	Frac	Dec	Frac
25405	84545	25406	3/4	x 3/4	x 1/2	1.11	1/8	1.02	1	2.26	2 1/4	1.55	1 9/16
25480	84550	25481	3/4	x 3/4	x 3/4	1.11	1/8	1.03	1	2.26	2 1/4	1.58	1 9/16
25410	84555	25411	1	x 1	x 1/2	1.23	1/4	1.19	1 9/16	2.57	2 9/16	1.73	1 3/4
25415	84560	25416	1	x 1	x 3/4	1.23	1/4	1.18	1 9/16	2.57	2 9/16	1.73	1 3/4
25485	84575	25486	1 1/4	x 1 1/4	x 1/2	1.41	1 7/16	1.31	1 9/16	3.23	3 1/4	1.85	1 7/8
25505	84570	25506	1 1/4	x 1 1/4	x 3/4	1.41	1 7/16	1.33	1 9/16	3.23	3 1/4	1.89	1 7/8
25500	84565	25501	1 1/4	x 1 1/4	x 1	1.41	1 7/16	1.37	1 9/16	3.23	3 1/4	2.03	2
25435	84580	25436	1 1/2	x 1 1/2	x 1/2	1.57	1 9/16	1.42	1 7/16	3.44	3 7/16	1.95	1 15/16
25440	84585	25441	1 1/2	x 1 1/2	x 3/4	1.57	1 9/16	1.41	1 7/16	3.44	3 7/16	1.97	2
25445	84590	25446	1 1/2	x 1 1/2	x 1	1.57	1 9/16	1.57	1 9/16	3.44	3 7/16	2.24	2 1/4
25450	NA	25451	1 1/2	x 1 1/2	x 1 1/4	1.57	1 9/16	1.47	1 1/2	3.44	3 7/16	2.15	2 1/8
25455	84595	25456	2	x 2	x 1/2	1.81	1 13/16	1.70	1 11/16	3.80	3 13/16	2.24	2 1/4
25460	84600	25461	2	x 2	x 3/4	1.81	1 13/16	1.72	1 3/4	3.80	3 13/16	2.28	2 1/4
25465	84605	25466	2	x 2	x 1	1.81	1 13/16	1.89	1 7/8	3.80	3 13/16	2.55	2 9/16
25470	NA	25471	2	x 2	x 1 1/4	1.81	1 13/16	1.77	1 3/4	3.80	3 13/16	2.45	2 7/16
25475	NA	25476	2	x 2	x 1 1/2	1.81	1 13/16	1.73	1 3/4	3.80	3 13/16	2.41	2 7/16

Viega MegaPress Tee P x P x FPT - Models 4817.2XL / 6617.2XL

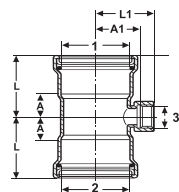

Part No.			Size (in)			A (in)		A1 (in)		L (in)		L1 (in)	
FKM	HNBR	1	2	3	Dec	Frac	Dec	Frac	Dec	Frac	Dec	Frac	
26625	28725	2 1/2	x 2 1/2	x 3/4	1.35	1 3/8	2.00	2	3.15	3 1/8	2.55	2 9/16	
26630	28730	3	x 3	x 3/4	1.44	1 7/16	2.24	2 1/4	3.74	3 3/4	2.80	2 13/16	
26635	28735	4	x 4	x 3/4	1.55	1 9/16	2.76	2 3/4	4.72	4 3/4	3.31	3 5/16	

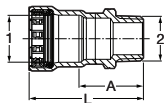
MegaPress Adapter, Carbon Steel, P x MPT - Models 4811 / 5911 / 6611

Part No.			Size (in)		A (in)		L (in)	
EPDM	FKM	HNBR	1	2	Dec	Frac	Dec	Frac
25100	84245	25101	1/2	x 1/2	1.45	1 7/16	2.52	2 1/2
25105	84250	25106	3/4	x 3/4	1.50	1 1/2	2.66	2 11/16
25110	84255	25111	1	x 1	1.66	1 11/16	3.00	3
25115	84260	25116	1 1/4	x 1 1/4	1.90	1 7/8	3.70	3 1/16
25120	84265	25121	1 1/2	x 1 1/2	1.93	1 15/16	3.80	3 13/16
25125	84270	25126	2	x 2	1.93	1 5/8	3.92	3 15/16

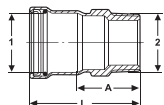
Viega MegaPress Adapter P x MPT - Models 4811XL / 6611XL

Part No.		Size (in)		A (in)		L (in)	
FKM	HNBR	1	2	Dec	Frac	Dec	Frac
26640	28740	2 1/2	x 2 1/2	2.75	2 3/4	4.55	4 7/16
26645	28745	3	x 3	2.89	2 7/8	5.20	5 3/16
26650	28750	4	x 4	3.03	3	6.21	6 3/16

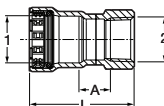
MegaPress Adapter, Carbon Steel, P x FPT - Models 4812 / 5912 / 6612

Part No.			Size (in)		A (in)		L (in)	
EPDM	FKM	HNBR	1	2	Dec	Frac	Dec	Frac
25130	84275	25131	1/2	x 1/2	0.69	7/16	2.29	2 5/16
25135	84280	25136	3/4	x 3/4	0.74	3/4	2.45	2 1/16
25140	84285	25141	1	x 1	0.73	3/4	2.74	2 3/4
25145	84290	25146	1 1/4	x 1 1/4	0.77	3/4	3.27	3 1/4
25150	84295	25151	1 1/2	x 1 1/2	0.72	3/4	3.28	3 1/4
25155	84300	25156	2	x 2	0.76	3/4	3.44	3 1/16

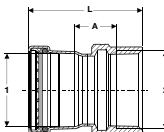
Viega MegaPress Adapter P x FPT - Models 4812XL / 6612XL

Part No.		Size (in)		A (in)		L (in)	
FKM	HNBR	1	2	Dec	Frac	Dec	Frac
26655	28755	2 1/2	x 2 1/2	1.13	1 1/8	3.86	3 7/8
26660	28760	3	x 3	1.17	1 3/16	4.49	4 1/2
26665	28765	4	x 4	1.15	1 1/8	5.42	5 1/16

MegaPress Reducing Adapter, Carbon Steel, P x FPT - Models 4812 / 5912 / 6612

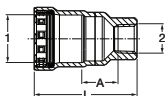

Part No.			Size (in)		A (in)		L (in)	
EPDM	FKM	HNBR	1	2	Dec	Frac	Dec	Frac
25575	84750	25576	¾ x ½		0.73	¾	2.43	2 ¹⁵ / ₁₆
25580	84755	25581	1 x ½		1.03	1	2.91	2 ¹⁵ / ₁₆
25585	84760	25586	1 x ¾		0.78	¾	2.68	2 ¹⁵ / ₁₆
25590	84765	25591	1¼ x ½		1.15	1 ¹ / ₈	3.50	3 ¹ / ₂
25595	84770	25596	1¼ x ¾		1.11	1 ¹ / ₈	3.48	3 ¹ / ₂
25600	84775	25601	1¼ x 1		0.76	¾	3.24	3 ¹ / ₄
25605	84780	25606	1½ x ½		1.31	1 ⁵ / ₁₆	3.72	3 ³ / ₄
25610	84785	25611	1½ x ¾		1.27	1¼	3.70	3 ¹⁵ / ₁₆
25615	84790	25616	1½ x 1		1.11	1 ¹ / ₈	3.64	3 ⁵ / ₈
25620	84795	25621	1½ x 1¼		0.86	7 ⁸ / ₁₆	3.41	3 ⁷ / ₁₆
25625	NA	25626	2 x ½		1.56	1 ⁹ / ₁₆	4.06	4 ¹ / ₁₆
25630	84800	25631	2 x ¾		1.54	1 ⁹ / ₁₆	4.08	4 ¹ / ₁₆
25635	84805	25636	2 x 1		1.35	1 ³ / ₈	4.00	4
25640	NA	25641	2 x 1¼		1.28	1¼	3.93	3 ¹⁵ / ₁₆
25645	84810	25646	2 x 1½		1.03	1	3.70	3 ¹⁵ / ₁₆

MegaPress Coupling with Stop, Carbon Steel, P x P - Models 4815 / 5915 / 6615

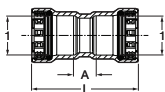

Part No.			Size (in)		A (in)		L (in)	
EPDM	FKM	HNBR	1		Dec	Frac	Dec	Frac
25000	84215	25001	½		0.56	9 ¹⁶ / ₁₆	2.70	2 ¹ / ₁₆
22005	84220	22009	¾		0.63	5 ⁸ / ₁₆	2.94	2 ¹⁵ / ₁₆
25010	84225	25011	1		0.59	9 ¹⁶ / ₁₆	3.29	3 ⁹ / ₁₆
25015	84230	25016	1¼		0.70	1 ¹ / ₁₆	4.34	4 ⁵ / ₁₆
25020	84235	25021	1½		0.89	7 ⁸ / ₁₆	4.63	4 ⁵ / ₈
25025	84240	25026	2		0.77	¾	4.75	4 ³ / ₄

Veiga MegaPress Coupling with Stop P x P - Models 4815XL / 6615XL

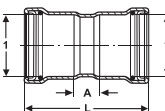

Part No.		Size (in)		A (in)		L (in)	
FKM	HNBR	1		Dec	Frac	Dec	Frac
26670	28770	2½		1.32	1 ⁵ / ₁₆	4.92	4 ¹⁵ / ₁₆
26675	28775	3		1.38	1 ³ / ₈	5.98	6
26680	28780	4		1.57	1 ⁹ / ₁₆	7.87	7 ⁷ / ₈

MegaPress Coupling No Stop, Carbon Steel, P x P - Models 4815.5 / 5915.5 / 6615.5

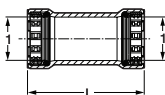

Part No.			Size (in)		L (in)	
EPDM	FKM	HNBR	1		Dec	Frac
25030	84130	25031	½		2.71	2 ¹ / ₁₆
25035	84135	25036	¾		2.94	2 ¹⁵ / ₁₆
25040	84140	25041	1		3.29	3 ⁹ / ₁₆
25045	84145	25046	1¼		4.34	4 ⁵ / ₁₆
25050	84150	25051	1½		4.63	4 ⁵ / ₈
25055	84155	25056	2		4.74	4 ³ / ₄

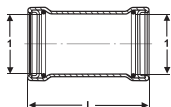
Viega MegaPress Coupling No Stop P x P - Models 4815.5XL / 6615.5XL

Part No.		Size (in)		L (in)	
FKM	HNBR	1	Dec	Frac	
26685	28785	2½	4.92	4 ¹⁵ / ₁₆	
26690	28790	3	5.98	6	
26695	28795	4	7.91	7 ¹⁵ / ₁₆	

MegaPress Extended No Stop Coupling, Carbon Steel, P x P - Models 4815.3 / 6615.3

Part No.		Size (in)		L (in)	
EPDM	HNBR	1	Dec	Frac	
25070	25071	½	3.82	3 ¹³ / ₁₆	
25075	25076	¾	4.00	4	
25080	25081	1	4.38	4 ³ / ₈	
25085	25086	1¼	5.33	5 ⁵ / ₁₆	
25090	25091	1½	5.44	5 ⁹ / ₁₆	
25095	25096	2	5.63	5 ⁵ / ₈	

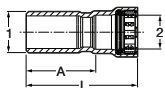
MegaPress Reducer, Carbon Steel, FTG x P - Models 4815.1 / 5915.1 / 6615.1

Part No.			Size (in)		A (in)		L (in)	
EPDM	FKM	HNBR	1	2	Dec	Frac	Dec	Frac
26000	84160	26001	¾ x ½		1.78	1¼	2.85	2 ⁷ / ₈
26005	84165	26006	1 x ½		2.14	2 ¹ / ₈	3.21	3 ³ / ₁₆
26010	84170	26011	1 x ¾		2.09	2 ¹ / ₁₆	3.24	3¼
NA	84175	NA	1¼ x ¾		2.81	2 ¹³ / ₁₆	3.97	4
26015	84180	26016	1¼ x 1		2.63	2 ⁵ / ₈	3.98	4
26020	84185	26021	1½ x ¾		2.98	3	4.13	4 ¹ / ₈
26025	84190	26031	1½ x 1		2.81	2 ¹³ / ₁₆	4.16	4 ³ / ₁₆
26030	84195	26026	1½ x 1¼		2.70	2 ¹¹ / ₁₆	4.52	4½
26035	84200	26036	2 x 1		3.14	3 ¹ / ₈	4.49	4½
26040	84205	26041	2 x 1¼		3.02	3	4.83	4 ¹³ / ₁₆
26045	84210	26046	2 x 1½		2.96	2 ¹⁵ / ₁₆	4.83	4 ¹³ / ₁₆

Viega MegaPress Reducer FTG x P - Models 4815.1XL / 6615.1XL

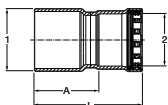

Part No.		Size (in)		A (in)		L (in)	
FKM	HNBR	1	2	Dec	Frac	Dec	Frac
26700	28800	2½	x 1	3.49	3½	4.83	4 ¹³ / ₁₆
26705	28805	2½	x 1¼	3.37	3¾	5.19	5 ⁵ / ₁₆
26710	28810	2½	x 1½	3.30	3 ⁵ / ₁₆	5.17	5 ³ / ₁₆
26715	28815	2½	x 2	2.97	3	4.96	4 ¹⁵ / ₁₆
26720	28820	3	x 1¼	4.16	4 ³ / ₁₆	5.98	6
26725	28825	3	x 1½	4.08	4 ¹ / ₁₆	5.95	5 ¹⁵ / ₁₆
26730	28830	3	x 2	3.76	3¾	5.75	5¾
26735	28835	3	x 2½	3.75	3¾	5.55	5 ⁹ / ₁₆
26740	28840	4	x 1½	5.60	5 ⁵ / ₈	7.47	7½
26745	28845	4	x 2	5.28	5¼	7.27	7¼
26750	28850	4	x 2½	5.27	5¼	7.06	7 ¹ / ₁₆
26755	28855	4	x 3	5.03	5	7.33	7 ⁵ / ₁₆

MegaPress Reducer, Carbon Steel, P x P - Models 4815.2 / 6615.2

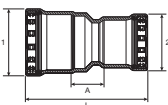

Part No.		Size (in)		A (in)		L (in)	
EPDM	HNBR	1	2	Dec	Frac	Dec	Frac
25930	25931	¾	x ½	1.20	1 ¹ / ₁₆	3.43	3 ⁷ / ₁₆
25935	25936	1	x ½	1.37	1 ³ / ₈	3.79	3 ¹³ / ₁₆
25940	25941	1	x ¾	1.24	1¼	3.74	3¾
25945	25946	1¼	x ¾	1.40	1 ³ / ₈	4.37	4 ³ / ₈
25950	25951	1¼	x 1	1.23	1¼	4.39	4 ³ / ₈
25955	25956	1½	x 1¼	1.21	1 ³ / ₁₆	4.90	4 ⁷ / ₈
25960	25961	2	x 1¼	1.45	1 ⁷ / ₁₆	5.27	5¼
25965	25966	2	x 1½	1.43	1 ⁷ / ₁₆	5.26	5¼

MegaPress Union, Carbon Steel, P x P - Model 4860 / 5960

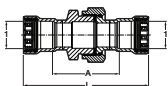

Part No.		Size (in)		A (in)		L (in)	
EPDM	FKM	1	2	Dec	Frac	Dec	Frac
25700	84815	½		2.35	2 ³ / ₈	4.50	4½
25705	84820	¾		2.67	2 ⁷ / ₁₆	4.99	5
25710	84825	1		2.65	2 ⁵ / ₈	5.34	5 ⁵ / ₁₆
25715	84830	1¼		2.84	2 ¹³ / ₁₆	6.48	6½
25720	84835	1½		2.89	2 ⁷ / ₈	6.63	6 ⁵ / ₈
25725	84840	2		3.92	3 ¹⁵ / ₁₆	7.89	7 ⁷ / ₈

MegaPress Union, Carbon Steel, P x P - Model 6660

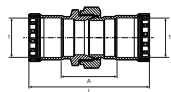

Part No. HNBR	Size (in)		A (in)		L (in)	
	1		Dec	Frac	Dec	Frac
25701	1/2		2.33	2 ⁹ / ₁₆	4.47	4 ¹ / ₂
25706	3/4		2.67	2 ¹¹ / ₁₆	4.98	5
25711	1		2.60	2 ⁵ / ₈	5.29	5 ⁵ / ₁₆
25716	1 ¹ / ₄		2.85	2 ⁷ / ₈	6.49	6 ¹ / ₂
25721	1 ¹ / ₂		2.90	2 ⁷ / ₈	6.64	6 ⁵ / ₈
25726	2		3.41	3 ³ / ₁₆	7.35	7 ³ / ₈

MegaPress Union, Carbon Steel, P x FPT - Model 4862

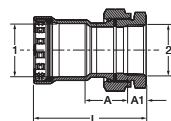

Part No. EPDM	Size (in)		A (in)		A1 (in)		L (in)	
	1	2	Dec	Frac	Dec	Frac	Dec	Frac
25650	1/2 x 1/2		1.25	1 ¹ / ₄	0.54	9 ⁹ / ₁₆	2.85	2 ⁷ / ₈
25655	3/4 x 3/4		1.48	1 ¹ / ₂	0.56	9 ⁹ / ₁₆	3.20	3 ³ / ₁₆
25660	1 x 1		1.37	1 ³ / ₈	0.66	1 ¹ / ₁₆	3.38	3 ³ / ₈
25665	1 ¹ / ₄ x 1 ¹ / ₄		1.53	1 ¹ / ₂	0.68	1 ¹ / ₁₆	4.03	4
25670	1 ¹ / ₂ x 1 ¹ / ₂		1.55	1 ⁹ / ₁₆	0.68	1 ¹ / ₁₆	4.10	4 ¹ / ₈
25675	2 x 2		2.33	2 ⁵ / ₁₆	0.70	1 ¹ / ₁₆	5.00	5

MegaPress Union, Carbon Steel, P x FPT - Model 6662

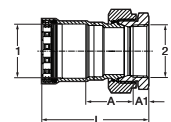

Part No. HNBR	Size (in)		A (in)		A1 (in)		L (in)	
	1	2	Dec	Frac	Dec	Frac	Dec	Frac
25651	1/2 x 1/2		1.38	1 ³ / ₈	0.54	9 ⁹ / ₁₆	2.98	3
25656	3/4 x 3/4		1.64	1 ⁵ / ₈	0.56	9 ⁹ / ₁₆	3.35	3 ³ / ₈
25661	1 x 1		1.62	1 ⁵ / ₈	0.66	1 ¹ / ₁₆	3.63	3 ⁵ / ₈
25666	1 ¹ / ₄ x 1 ¹ / ₄		1.85	1 ⁷ / ₈	0.68	1 ¹ / ₁₆	4.35	4 ³ / ₈
25671	1 ¹ / ₂ x 1 ¹ / ₂		1.80	1 ¹³ / ₁₆	0.68	1 ¹ / ₁₆	4.35	4 ³ / ₈
25676	2 x 2		2.11	2 ¹ / ₈	0.70	1 ¹ / ₁₆	4.77	4 ³ / ₄

MegaPress Flange Class 150 Raised Face, Carbon Steel, P - Models 5959.5 / 6659.5

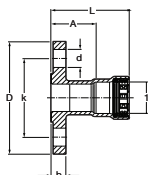

Part No.	FKM	HNBR	Size (in)		A (in)		L (in)		b (in)		k (in)		D (in)		d (in)	
			1	Dec	Frac	Dec	Frac	Dec	Frac	Dec	Frac	Dec	Frac	Dec	Frac	
84845	25761		½	1.51	1½	2.58	2⅞	0.46	⅞	2.36	2⅞	3.54	3⅞	0.63	⅝	
84850	25766		¾	1.58	1⅞	2.74	2¾	0.52	½	2.76	2¾	3.94	3⅝	0.63	⅝	
84855	25771		1	1.75	1¾	3.10	3⅞	0.58	⅞	3.11	3⅞	4.33	4⅞	0.63	⅝	
84860	25776		1¼	1.89	1⅞	3.71	3⅞	0.64	⅝	3.50	3½	4.53	4½	0.63	⅝	
84865	25781		1½	2.06	2⅞	3.93	3⅝	0.70	⅞	3.86	3⅞	4.92	4⅝	0.63	⅝	
84870	25786		2	2.07	2⅞	4.06	4⅞	0.77	¾	4.76	4¾	5.91	5⅝	0.75	¾	

Viega MegaPress Adapter Flange Class 150 Raised Face, P - Model 4859.5XL

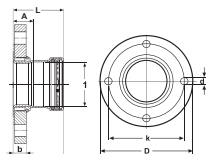

Part No.	FKM	Size (in)	A (in)		L (in)		b (in)		k (in)		D (in)		d (in)	
			1	Dec	Frac	Dec	Frac	Dec	Frac	Dec	Frac	Dec	Frac	Dec
26775		2½	1.54	1⅞	3.33	3⅞	0.89	⅞	5.51	5½	7.09	7⅞	0.75	¾
26780		3	1.65	1⅝	3.95	3⅝	0.96	⅝	5.98	6	7.48	7½	0.75	¾
26785		4	1.63	1⅝	4.80	4⅞	0.96	⅝	7.52	7½	9.06	9⅞	0.75	¾

Viega MegaPressG Adapter Flange Class 125 Flat Face, P - Model 6659.5XL

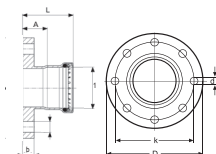

Part No.	HNBR	Size (in)	A (in)		L (in)		b (in)		k (in)		D (in)		d (in)	
			1	Dec	Frac	Dec	Frac	Dec	Frac	Dec	Frac	Dec	Frac	Dec
28875		2½	1.54	1⅞	3.33	3⅞	0.89	⅞	5.51	5½	7.09	7⅞	0.75	¾
28880		3	1.65	1⅝	3.95	3⅝	0.96	⅝	5.98	6	7.48	7½	0.75	¾
28885		4	1.63	1⅝	4.80	4⅞	0.96	⅝	7.52	7½	9.06	9⅞	0.75	¾

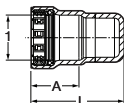
MegaPress Cap, Carbon Steel, P x Cap - Models 4856 / 5956 / 6656

Part No.			Size (in)		A (in)		L (in)	
EPDM	FKM	HNBR	1	Dec	Frac	Dec	Frac	
25730	84100	25731	½	1.07	1 ⅙	2.14	2 ⅘	
25735	84105	25736	¾	1.16	1 ⅙	2.26	2 ¼	
25740	84110	25741	1	1.35	1 ⅜	2.43	2 ⅞	
25745	84115	25746	1 ¼	1.82	1 ⅞	2.93	2 ⅝	
25750	84120	25751	1 ½	1.87	1 ⅞	3.02	3	
25755	84125	25756	2	1.99	2	3.11	3 ⅞	

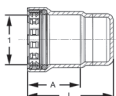
Viega MegaPress Cap P - Models 4856.1XL / 6656.1XL

Part No.		Size (in)		A (in)		L (in)	
FKM	HNBR	1	Dec	Frac	Dec	Frac	
26760	28860	2 ½	1.80	1 ⅞	3.27	3 ¼	
26765	28865	3	2.30	2 ⅝	3.78	3 ¾	
26770	28870	4	3.18	3 ⅞	4.65	4 ⅞	

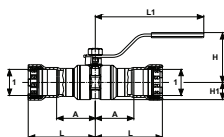
MegaPress Ball Valve, Carbon Steel, P x P - Models 4870 / 5970 / 5970XL

Part No.		Size (in)		A (in)		L (in)		L1 (in)		H (in)		H1 (in)	
EPDM	FKM	1	Dec	Frac	Dec	Frac	Dec	Frac	Dec	Frac	Dec	Frac	
28915	28945	½	1.54	1 ⅙	2.62	2 ⅝	4.57	4 ⅞	1.99	2	0.63	⅝	
28920	28950	¾	1.64	1 ⅝	2.80	2 ⅞	4.57	4 ⅞	2.10	2 ⅞	0.75	¾	
28925	28955	1	1.81	1 ⅞	3.16	3 ⅞	5.77	5 ¾	2.47	2 ½	0.88	⅞	
28930	28960	1 ¼	1.98	2	3.80	3 ⅞	5.77	5 ¾	2.71	2 ⅞	1.14	1 ⅞	
28935	28965	1 ½	2.14	2 ⅞	4.01	4	6.12	6 ⅞	3.02	3	1.36	1 ⅞	
28940	28970	2	2.38	2 ⅞	4.37	4 ⅞	6.12	6 ⅞	3.32	3 ⅞	1.65	1 ⅞	
NA	86790	2 ½	3.72	3 ¾	5.52	5 ½	11.09	11 ⅞	5.13	5 ⅞	2.39	2 ⅞	
NA	86795	3	4.07	4 ⅞	6.40	6 ⅞	11.09	11 ⅞	5.52	5 ½	2.80	2 ⅞	
NA	86800	4	4.67	4 ⅞	7.84	7 ⅞	13.06	13 ⅞	6.70	6 ⅞	3.45	3 ⅞	

MegaPress 3-Piece Ball Valve, Carbon Steel, P x P - Models 4875.8 / 5975.8 / 5975.8XL

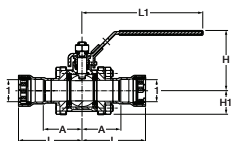

Part No.	Size (in)*	A (in)		L (in)		L1 (in)		H (in)		H1 (in)		
		1	Dec	Frac	Dec	Frac	Dec	Frac	Dec	Frac	Dec	Frac
28500	86400	1/2	1.72	1 3/4	2.80	2 13/16	5.88	5 7/8	2.85	2 7/8	1.04	1 1/16
28501	86405	3/4	1.91	1 15/16	3.06	3 1/16	5.88	5 7/8	2.93	2 15/16	1.16	1 3/16
28502	86410	1	2.19	2 3/16	3.54	3 9/16	7.54	7 9/16	3.33	3 3/16	1.40	1 3/8
28503	86415	1 1/4	2.50	2 1/2	4.31	4 5/16	7.54	7 9/16	3.57	3 9/16	1.57	1 9/16
28504	86420	1 1/2	2.92	2 15/16	4.79	4 13/16	7.54	7 9/16	3.89	3 7/8	1.83	1 13/16
28505	86425	2	3.09	3 1/16	5.07	5 1/16	7.54	7 9/16	3.89	3 7/8	1.83	1 13/16
NA	86680	2 1/2	3.74	3 3/4	5.54	5 9/16	11.06	11 1/16	5.08	5 1/16	2.28	2 1/4
NA	86685	3	4.37	4 3/8	6.67	6 1/16	11.06	11 1/16	5.47	5 1/2	2.68	2 7/16
NA	86690	4	4.88	4 7/8	8.06	8 1/16	13.07	13 1/16	6.89	6 7/8	3.79	3 13/16

Sizes up to 3" have 4-bolt flanges; 4" has 6-bolt flanges.

Viega MegaPressG Ball Valve - Model 6675 / 6675XL

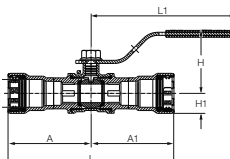

Part No.	Size (in)	A (in)		L (in)		L1 (in)		H (in)		H1 (in)	
		1	Dec	Frac	Dec	Frac	Dec	Frac	Dec	Frac	Dec
30630	1/2	2.62	2 5/8	5.24	5 1/4	4.57	4 9/16	1.99	2	0.63	5/8
30635	3/4	2.80	2 13/16	5.59	5 9/16	4.57	4 9/16	2.10	2 1/8	0.77	3/4
30640	1	3.16	3 3/16	6.31	6 5/16	5.77	5 3/4	2.46	2 7/16	0.91	15/16
30645	1 1/4	3.78	3 3/4	7.55	7 1/16	5.77	5 3/4	2.69	2 1/16	1.14	1 1/8
30650	1 1/2	3.98	4	7.97	8	6.12	6 1/8	3.02	3	1.36	1 3/8
30655	2	4.35	4 3/8	8.70	8 1/16	6.12	6 1/8	3.31	3 3/16	1.65	1 5/8
86840	2 1/2	3.72	3 3/4	11.04	11 1/16	11.09	11 1/16	5.14	5 1/8	2.40	2 3/8
86845	3	4.07	4 1/8	12.80	12 3/4	11.09	11 1/16	5.54	5 9/16	2.80	2 3/4
86850	4	4.67	4 1/16	15.68	15 1/16	13.06	13 1/16	6.70	6 1/16	3.45	3 7/16

Viega MegaPressG Ball Valve - Model 6675.1

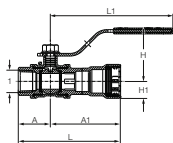

Part No.	Size (in)	A (in)		A1 (in)		L (in)		L1 (in)		H (in)		H1 (in)	
		1	Dec	Frac	Dec	Frac	Dec	Frac	Dec	Frac	Dec	Frac	Dec
30630	1/2	1.20	13/16	2.62	25/8	3.82	33/16	4.57	49/16	1.99	2	0.63	5/8
30635	3/4	1.36	13/8	2.80	23/16	4.15	41/8	4.57	49/16	2.10	21/8	0.77	3/4
30640	1	1.85	17/8	3.16	33/16	5.00	5	5.77	53/4	2.46	27/16	0.91	15/16
30645	1 1/4	1.87	17/8	3.78	33/4	5.64	55/8	5.77	53/4	2.69	21/16	1.14	11/8
30650	1 1/2	2.05	21/16	3.98	4	6.03	6	6.12	61/8	3.02	3	1.36	13/8
30655	2	2.43	27/16	4.35	43/8	6.78	63/4	6.12	61/8	3.31	33/16	1.65	13/8

Viega MegaPressG Ball Valve - Model 6675.2

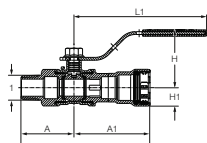

Part No.	Size (in)	A (in)		A1 (in)		L (in)		L1 (in)		H (in)		H1 (in)	
		1	Dec	Frac	Dec	Frac	Dec	Frac	Dec	Frac	Dec	Frac	Dec
30630	1/2	1.81	113/16	2.62	25/8	4.44	47/16	4.57	49/16	0.63	5/8	1.99	2
30635	3/4	1.87	17/8	2.80	23/16	4.64	49/8	4.57	49/16	0.77	3/4	2.10	21/8
30640	1	2.53	21/2	3.16	33/16	5.69	511/16	5.77	53/4	0.91	15/16	2.46	27/16
30645	1 1/4	2.56	29/16	3.78	33/4	6.33	63/16	5.77	53/4	1.14	11/8	2.69	211/16
30650	1 1/2	2.67	21/16	3.98	4	6.65	63/8	6.12	61/8	1.36	13/8	3.02	3
30655	2	2.92	215/16	4.35	43/8	7.28	71/4	6.12	61/8	1.65	13/8	3.31	33/16

Viega MegaPressG Ball Valve - Model 6675.3

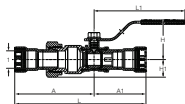

Part No.	Size (in)	A (in)		A1 (in)		L (in)		L1 (in)		H (in)		H1 (in)	
		1	Dec	Frac	Dec	Frac	Dec	Frac	Dec	Frac	Dec	Frac	Dec
30630	1/2	4.00	4	2.62	25/8	6.62	63/8	4.57	49/16	1.99	2	0.89	7/8
30635	3/4	4.19	43/16	2.80	23/16	6.99	7	4.57	49/16	2.10	21/8	1.08	11/16
30640	1	4.53	41/2	3.16	33/16	7.69	711/16	5.77	53/4	2.46	27/16	1.18	13/16
30645	1 1/4	5.65	53/8	3.78	33/4	9.43	97/16	5.77	53/4	2.69	21/16	1.50	11/2
30650	1 1/2	5.59	59/16	3.98	4	9.57	99/16	6.12	61/8	3.02	3	1.50	11/2
30655	2	6.53	61/2	4.35	43/8	10.88	107/8	6.12	61/8	3.31	33/16	1.65	13/8

Q How would an inspector know they are looking at a good connection?

A Good connections can be proven by performing a pressure test. This is the same procedure for threaded systems.

Q What steel pipe schedules can Viega MegaPress be installed with?

A Viega MegaPress may be installed with schedule 5 to schedule 40 ASTM A53, ASTM A795, or ASTM A135 black steel pipe. National codes require the use of schedule 10 and schedule 40 ASTM A53 black steel pipe for fuel gas applications. All applications must be compliant with local code requirements.

Q Do I have to lubricate the pipe or the fitting?

A No, Viega does not require lubrication of the pipe or the fitting.

Q Can I install Viega MegaPress fittings on epoxy coated pipe?

A Yes, the surface of the pipe must be smooth before installing the fittings. Surface smoothing can be accomplished by using the RIDGID Pipe Prep tool or an abrasive sanding cloth.

Q Is Viega MegaPress approved for underground installation?

A Yes, Viega MegaPress systems may be installed underground but must be protected per the national codes and the local authority.

Q What is the procedure for welding near a Viega MegaPress fitting?

A When welding adjacent to a Viega MegaPress fitting, a minimum four inches of space should be allowed to avoid overheating and damaging the sealing element. When welding a fitting in line with a Viega MegaPress fitting, a minimum distance of three feet should be maintained. The Viega MegaPress fitting should also be protected from overheating through use of a cooling agent or welding blanket.

Q Can Viega MegaPress fittings be installed in a potable water application?

A No, Viega MegaPress is not certified for potable water usage.

Q Can Viega MegaPress fittings be installed in a natural gas application?

A Only Viega MegaPressG with HNBR sealing elements are certified by CSA to be installed in natural gas applications.

Q What is the maximum temperature that Viega MegaPressG, with HNBR sealing elements, can be exposed to?

A Viega MegaPressG has been certified by CSA LC4 to withstand 1,000° F for one hour.

Q What is Smart Connect technology?

A Smart Connect technology provides a quick and easy way to identify unpressed connections during the pressure-testing process. Unpressed connections are located by pressurizing the system with air or water. When testing with air or water, the pressure range is 15 psi to 85 psi maximum. The flow path is removed during the pressing process, creating a leakproof, reliable connection. Guaranteed.

Q Why is Smart Connect technology so valuable?

A Smart Connect technology gives the user strong peace of mind. It allows for faster testing procedures since you do not have to shut down and drain the system. Costly damages and possible insurance claims and premiums can be avoided because it identifies unpressed connections before they can become a problem. Because of the time savings, projects stay on track.

Viega MegaPress Limited Warranty

Subject to the conditions and limitations in this Limited Warranty, Viega LLC (Viega) warrants to end users, installers, and distribution houses that its Viega MegaPress metal press fittings including MegaPress, MegaPress FKM, MegaPress 304 FKM, MegaPress 316, and MegaPress 316 FKM (Viega Product) with application appropriate sealing element when properly installed in non-industrial and non-marine applications and under specified operating conditions of use shall be free from failure caused by manufacturing defects for a period of fifteen (15) years from date of installation. MegaPress valves, when properly installed and under normal conditions of use, will be free of failure from manufacturing defects for a period of five (5) years from date of installation.

Under this Limited Warranty, you only have a right to a remedy if the failure or leak resulted from a manufacturing defect in the Viega Product and the failure or leak occurs during the warranty period. You do not have a remedy under this warranty and the warranty remedy does not apply if the failure or any resulting damage is caused by (1) components other than those manufactured or sold by Viega, such as black iron pipe; (2) not designing, installing, inspecting, testing, or maintaining the Viega Product in accordance with Viega's installation and product instructions in effect at the time of installation, and other specifications and approvals applicable to the installation; (3) use of Viega Product under non recommended system operating conditions, improper handling, and protection of the Viega Product prior to, during, and after installation, inadequate freeze protection, or exposure to environmental conditions not recommended for the application; or (4) acts of nature, such as, but not limited to, earthquakes, fire, or weather damage. In the event of a leak or other failure of the Viega Product covered by this warranty, it is the responsibility of the end user to take appropriate measures to mitigate any damage, to include making timely repairs. Only if the warranty applies will Viega be responsible for the remedy under this warranty. The part or parts which you claim failed should be kept and Viega contacted by writing to the address on

the back page or telephoning 1-800-976-9819 within thirty (30) calendar days after the leak or other failure and identifying yourself as having a warranty claim. You should be prepared to ship, at your expense, the product which you claim failed due to a manufacturing defect, and document the date of installation and the amount of the repair or replacement if performed by you. Within a reasonable time after receiving the product, Viega will investigate the reasons for the failure, which includes the right to inspect the product at a Viega location and reasonable access to the site of damage. Viega will notify you in writing as to the results of its review.

In the event that Viega determines that the failure or leak was the result of a manufacturing defect in the Viega Product covered by this warranty and this warranty applies, the **EXCLUSIVE AND ONLY REMEDY** under this warranty shall be the reimbursement for reasonable charges for repair or replacement of the Viega Product itself. **VIEGA SHALL NOT BE LIABLE FOR ANY CONSEQUENTIAL OR OTHER DAMAGE (FOR EXAMPLE, ECONOMIC LOSS, WATER OR PROPERTY OR MOLD REMEDIATION) UNDER ANY LEGAL THEORY AND WHETHER ASSERTED BY DIRECT ACTION, FOR CONTRIBUTION OR INDEMNITY OR OTHERWISE.**

THE ABOVE WARRANTY IS IN LIEU OF ALL OTHER WARRANTIES, EXPRESS OR IMPLIED, INCLUDING, BUT NOT LIMITED TO, THE IMPLIED WARRANTIES OF MERCHANTABILITY AND FITNESS FOR A PARTICULAR PURPOSE OR ANY STATUTE OF LIMITATIONS RELATING TO SUCH WARRANTIES. Other than this Limited Warranty, Viega does not authorize any person or firm to create for it any other obligation or liability in connection with its products.

This Limited Warranty gives you specific legal rights and you also may have other rights which may vary from state to state. This warranty shall be interpreted and applied under the law of the state in which the product is installed and is intended as a **COMMERCIAL WARRANTY**.

Viega MegaPressG Limited Warranty

Subject to the conditions and limitations in this Limited Warranty, Viega LLC (Viega) warrants to end users, installers, and distribution houses that its Viega MegaPressG metal press fittings (Viega Product) with application appropriate sealing element when properly installed in non-industrial and non-marine applications and Viega MegaPressG Approved Applications for natural and fuel gases and lubricant, and approved fuels, lubricants, and oils, under Viega specified system operating conditions, shall be free from failure caused by manufacturing defects for a period of fifteen (15) years from date of installation. MegaPressG Valves, when properly installed and under normal conditions of use, will be free of failure from manufacturing defects for a period of five (5) years from date of installation.

Under this Limited Warranty, you only have a right to a remedy if the failure or leak resulted from a manufacturing defect in the Viega Product and the failure or leak occurs during the warranty period. You do not have a remedy under this warranty and the warranty remedy does not apply if the failure or any resulting damage is caused by (1) components other than those manufactured or sold by Viega, such as black iron pipe; (2) not designing, installing, inspecting, testing, or maintaining the Viega Product in accordance with Viega's installation and product instructions in effect at the time of installation, and other specifications and approvals applicable to the installation; (3) use of Viega Product under non recommended system operating conditions, improper handling, and protection of the Viega Product prior to, during, and after installation, inadequate freeze protection, or exposure to environmental conditions not recommended for the application; or (4) acts of nature, such as, but not limited to, earthquakes, fire, or weather damage. In the event of a leak or other failure of the Viega Product covered by this warranty, it is the responsibility of the end user to take appropriate measures to mitigate any damage, to include making timely repairs. Only if the warranty applies will Viega be responsible for the remedy under this warranty. The part or parts which you claim failed should be kept and

Viega contacted by writing to the address below or telephoning 1-800-976-9819 within thirty (30) calendar days after the leak or other failure and identifying yourself as having a warranty claim. You should be prepared to ship, at your expense, the product which you claim failed due to a manufacturing defect, and document the date of installation and the amount of the repair or replacement if performed by you. Within a reasonable time after receiving the product, Viega will investigate the reasons for the failure, which includes the right to inspect the product at a Viega location and reasonable access to the site of damage. Viega will notify you in writing as to the results of its review.

In the event that Viega determines that the failure or leak was the result of a manufacturing defect in the Viega Product covered by this warranty and this warranty applies, the **EXCLUSIVE AND ONLY REMEDY** under this warranty shall be the reimbursement for reasonable charges for repair or replacement of the Viega Product itself. **VIEGA SHALL NOT BE LIABLE FOR ANY CONSEQUENTIAL OR OTHER DAMAGE (FOR EXAMPLE, ECONOMIC LOSS, WATER OR PROPERTY OR MOLD REMEDIATION) UNDER ANY LEGAL THEORY AND WHETHER ASSERTED BY DIRECT ACTION, FOR CONTRIBUTION OR INDEMNITY OR OTHERWISE.**

THE ABOVE WARRANTY IS IN LIEU OF ALL OTHER WARRANTIES, EXPRESS OR IMPLIED, INCLUDING, BUT NOT LIMITED TO, THE IMPLIED WARRANTIES OF MERCHANTABILITY AND FITNESS FOR A PARTICULAR PURPOSE OR ANY STATUTE OF LIMITATIONS RELATING TO SUCH WARRANTIES. Other than this Limited Warranty, Viega does not authorize any person or firm to create for it any other obligation or liability in connection with its products.

This Limited Warranty gives you specific legal rights and you also may have other rights which may vary from state to state. This warranty shall be interpreted and applied under the law of the state in which the product is installed and is intended as a **COMMERCIAL WARRANTY**.

Viega Metal Systems for Industrial Applications Limited Warranty

Industrial applications are defined as non-residential and non-commercial applications not normally accessible to the general public, including manufacturing, mining, process or fabrication environments.

Subject to the terms and conditions of this Limited Warranty, Viega LLC (Viega) warrants to end users, installers, and distribution houses that its Viega metal press products (Viega Product) when properly installed in industrial applications shall be free from failure caused by manufacturing defects for a period of two (2) years from date of installation.

Under this Limited Warranty, you only have a right to a remedy if the failure or leak resulted from a manufacturing defect in the Viega Product and the failure or leak occurs during the warranty period. You do not have a remedy under this warranty and the warranty remedy does not apply if the failure or any resulting damage is caused by (1) components other than those sold by Viega; (2) not designing, installing, inspecting, testing, or maintaining the Viega Product in accordance with Viega's installation and product instructions in effect at the time of installation and other specifications and approvals applicable to the installation; (3) improper handling and protection of the Viega Product prior to, during, and after installation; inadequate freeze protection; or exposure to environmental or operating conditions not recommended for the application; or (4) acts of nature, such as, but not limited to, earthquakes, fire, flood, lightning, or weather damage. Final approval as to use compatibility to a specific process or fluid application is the responsibility of the engineer of record or responsible design/facilities personnel, and this Limited Warranty only applies to manufacturing defects in the Viega Product.

In the event of a leak or other failure in the Viega Product covered by this warranty, it is the responsibility of the end user to take appropriate measures to diminish any damage, to include making timely repairs. Only if the warranty applies will Viega be responsible for the remedy under this warranty. The part or parts which you claim failed should be kept and Viega contacted by writing to the address on the back page or telephoning 1-800-976-9819 within thirty (30)

calendar days after the leak or other failure and identifying yourself as having a warranty claim. You should be prepared to ship, at your expense, the product which you claim failed due to a manufacturing defect; and document the date of installation and the amount of the repair or replacement if performed by you. Within a reasonable time after receiving the product, Viega will investigate the reasons for the failure, which includes the right to inspect the product at a Viega location and reasonable access to the site of damage. Viega will notify you in writing as to the results of its review.

In the event that Viega determines that the failure or leak was the result of a manufacturing defect in the Viega Product covered by this warranty and to which this warranty applies, the EXCLUSIVE AND ONLY REMEDY under this warranty shall be the reimbursement for reasonable charges for repair or replacement of the Viega Product itself. VIEGA SHALL NOT BE LIABLE FOR CONSEQUENTIAL OR OTHER DAMAGE (FOR EXAMPLE, ECONOMIC LOSS OR WATER, PROPERTY, OR MOLD REMEDIATION) UNDER ANY LEGAL THEORY AND WHETHER ASSERTED BY DIRECT ACTION, FOR CONTRIBUTION OR INDEMNITY OR OTHERWISE.

THE ABOVE WARRANTY IS IN LIEU OF ALL OTHER WARRANTIES, EXPRESS OR IMPLIED, INCLUDING, BUT NOT LIMITED TO, THE IMPLIED WARRANTIES OR ANY STATUTE OF LIMITATIONS RELATING TO SUCH WARRANTIES. Other than this Limited Warranty, Viega does not authorize any person or firm to create for it any other obligation or liability in connection with its products.

This Limited Warranty gives you specific legal rights, and you also may have other rights, which may vary from state to state. This warranty shall be interpreted and applied under the law of the state in which the product is installed and is intended as a Commercial Warranty.



Viega LLC

585 Interlocken Blvd.
Broomfield, CO 80021

Ph: 800-976-9819
Fax: 800-976-9817
www.viega.us

